

KVALITA ZA SKVELÚ CENU!

33 JAHRE
ANS-YEARS
1992-2025

KS TOOLS

TOP DEAL

Infinitool

Vrátane PRIPOMIENKY SERVISU

START 1 6 12 MONTH

Infinitool

516.9042

INFINITOOL
Momentový kľúč s račňou

79,00

20 - 200 Nm

1/2"



Všetky ceny v EUR bez DPH platia do 30.9.2025

**performance
plus**



ÚSPECH VĎAKA VÝKONU



P₁₀

1850,⁰⁰

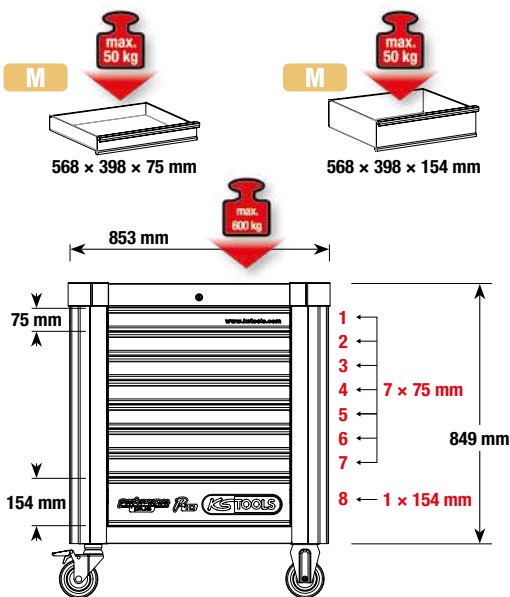

- S držiakom na kotúč papiera
- S držiakom na dózy
- Stabilné guľôčkové ložiská
- Integrovaná ochrana hrán
- Antistatické kolieska s brzdou



810.4241 Dielenský vozík P10 so 241 dielmi náradia



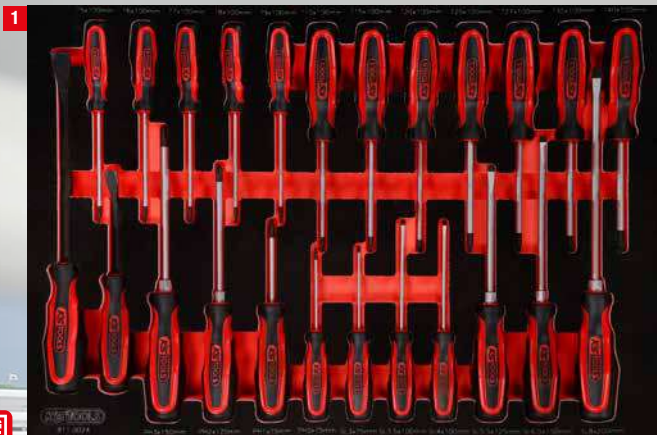

TLG
24

Súprava kliešti a skrutkovačov



TLG
41

Súprava skrutkových kľúčov



TLG
159

1/4" + 3/8" + 1/2" súprava nástrčkových kľúčov



TLG
17

Súprava kliešti, kladív a sekáčov

**PLASTOVÁ VLOŽKA
NA ÚSCHOVU
PRE VŠETKY *performance*
DIELENSKÉ VOZÍKY**



Ďalšie informácie

875.9904

L mm	B mm	H mm
395	140	50

4 + 1 PRIEHRADKA

5,00



Ďalšie informácie

875.9905

L mm	B mm	H mm
395	140	50

5 PRIEHRADIEK

5,00



Ďalšie informácie

875.9908

L mm	B mm	H mm
395	280	50

8 PRIEHRADIEK

10,00



Ďalšie informácie

875.9912

L mm	B mm	H mm
395	280	50

12 PRIEHRADIEK

10,00



Ďalšie informácie

875.9918

L mm	B mm	H mm
395	280	50

18 PRIEHRADIEK

10,00



VÝKON V DVOCH BALENIACH!

KTORÝ PERFORMANCE BALÍČEK JE TEN VÁŠ?

P10

Ďalšie informácie

397

1 OPTION 0

EDELSTAHL
ROSTFREI

527 mm

1.026 mm

853 mm

Ø 125 mm

Integrovaná ochrana hrán

2800,00

810.7397 Dielenský vozík P10 so 397 dielmi náradia

P15

Ďalšie informácie

397

1 OPTION 0

510 mm

1.025 mm

840 mm

Ø 125 mm

2900,00

815.7397 Dielenský vozík P15 so 397 dielmi náradia

845 mm

max. 600 kg

75 mm

1 2 3 4 5 6 7 8

7 x 75 mm

848 mm

1 x 154 mm

154 mm

M

max. 50 kg

568 x 398 x 75 mm

S držiakom na kotúč papiera

M

max. 50 kg

568 x 398 x 154 mm

Stabilné guľôčkové ložiská

S držiakom na dózy

Antistatické kolieska s brzdou



**DIELENSKÝ VOZÍK
S 397 DIELMI NÁRADIA**

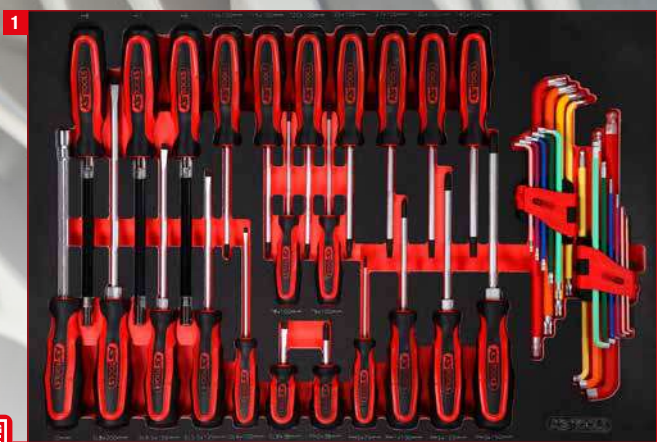

41 Súprava klieští a skrutkovačov



111 1/4" + 3/8" + 1/2" súprava nástrčkových kľúčov

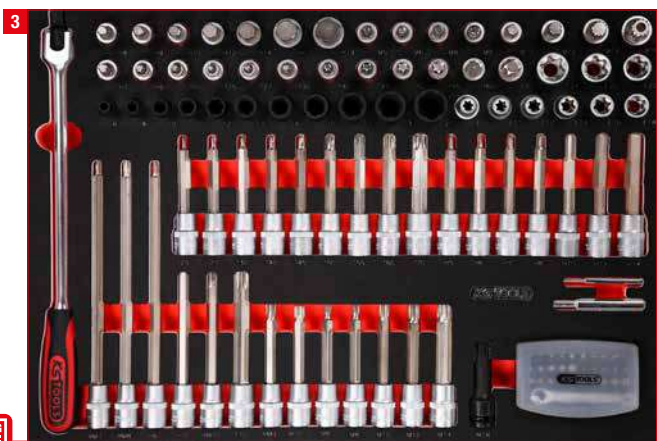

111 Súprava nástrčných orechov s bitmi 1/2"



41 Súprava skrutkových kľúčov



28 Súprava klieští a pilníkov



43 Súprava na výmenu oleja a servis pneumatík



22 Súprava kladív a sekáčov

VÝKON JE VAŠE PLUS

ROZŠÍRTE SVOJE OBZORY!

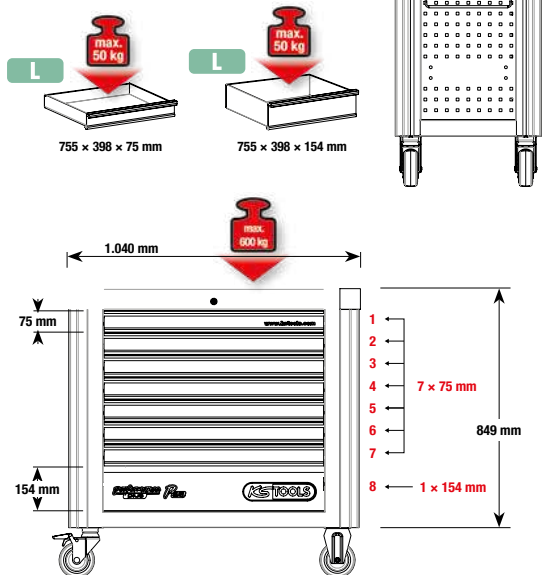

3945,00

825.8564 Dielenský vozík P25 so 564 dielmi náradia

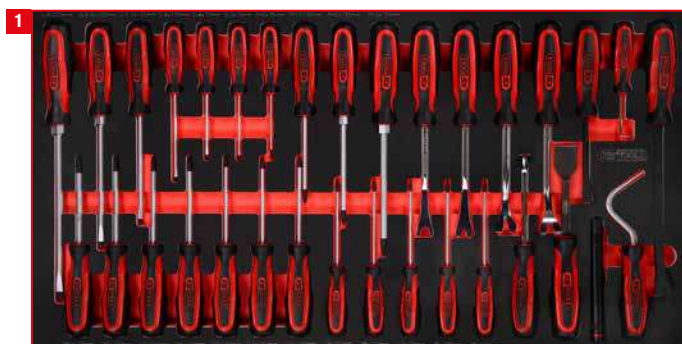

Súprava klieští a skrutkovačov



1/4" + 3/8" súprava nástrčkových kľúčov



1/2" súprava nástrčkových kľúčov



Súprava skrutkových kľúčov



performance
plus



Integrovaná ochrana hrán



S držiakom na dózy



Stabilné guľôčkové ložiská



Antistatické kolieska s brzdou



Uzamykatelná zámka



1 / 0
Option

s **564**
DIELMI NÁRADIA



Súprava skrutkových kľúčov



Súprava skrutkovačov a pilníkov



Súprava klieští a meracieho náradia



Súprava kladív, sekáčov a silových nástřných kľúčov





**performance
plus**

SILA A VÝKON

SO SKUTOČNOU HĽBKOU!

i  **706**
 Ďalšie informácie

XL  **max. 50 kg**
 790 x 568 x 75 mm

XL  **max. 50 kg**
 790 x 568 x 154 mm

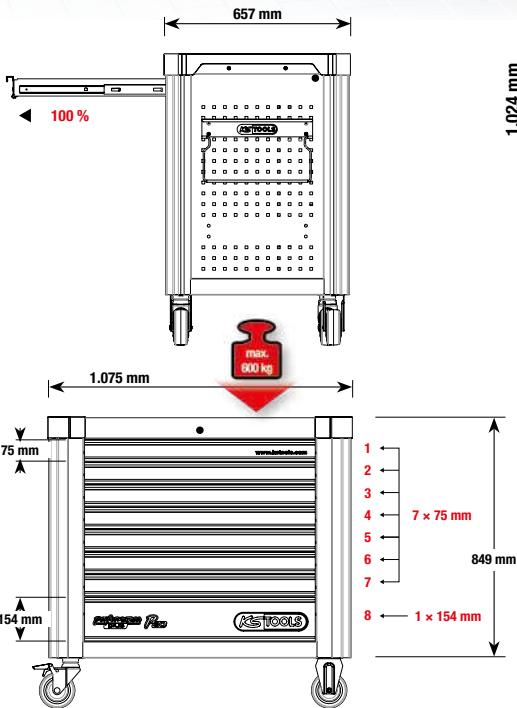

5890,00

830.9706 Dielenský vozík P30 so 706 dielmi náradia

KSTOOLS

8

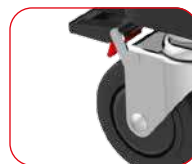

s 706 DIELMI NÁRADIA

657 x 1.075 MM 4 x M & 5 x XL

M 1 2 3 4
568 x 388 mm

XL 5 6 7 8 9
782 x 568 mm



76

Súprava skrutkových kľúčov

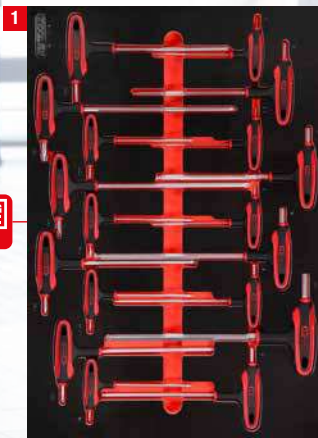

18

Súprava uhlových čapových kľúčov s T-rukavätou

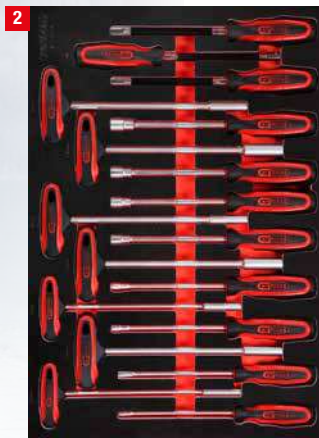

18

Súprava uhlových čapových kľúčov s T-rukavätou



221

3/8" súprava nástrčkových kľúčov



20

Súprava kladív a sekáčov



28

Súprava meracích prístrojov a pilníkov



149

1/2" súprava nástrčkových kľúčov

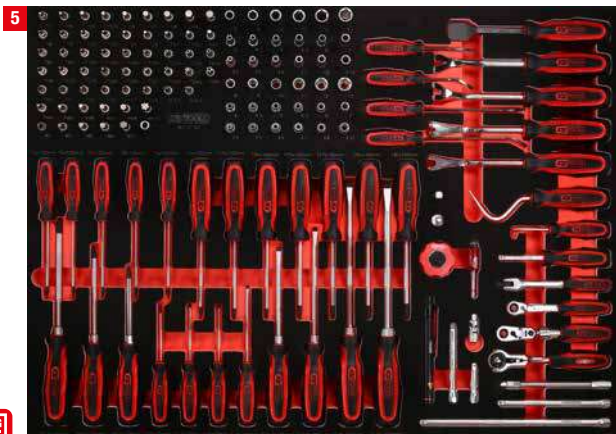

142

1/4" súprava nástrčkových kľúčov a skrutkovačov



34

Súprava klieští

VÝKON JE VAŠE PLUS

VEĽKOKAPACITNÝ VOZÍK!

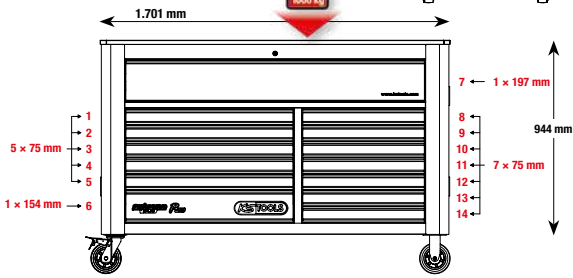
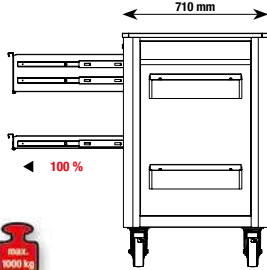

9100,00

845.14950 Dielenský vozík P45 so 950 dielmi náradia

s **950**
DIELMI NÁRADIA

7 x M

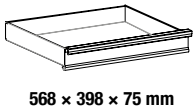
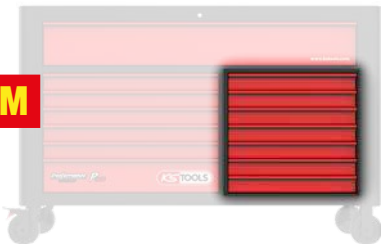

M

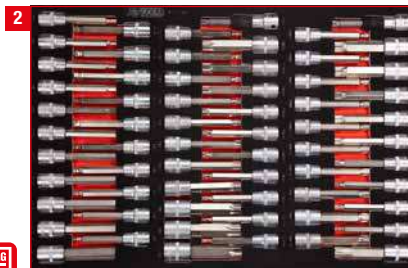

Súprava nástrčných orechov s bitmi 1/2"



Súprava skrutkovačov a hákov



1/2" súprava silových nástrčných orechov



Súprava uhlových čapových kľúčov s T-rukovätou



1/4" súprava nástrčkových kľúčov



Súprava skrutkových kľúčov

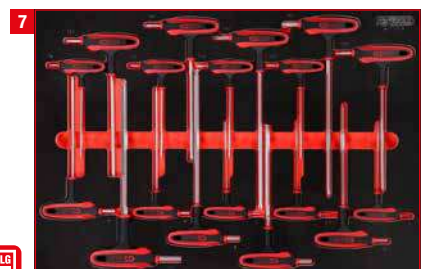

Súprava uhlových čapových kľúčov s T-rukovätou



ITLG
46

Súprava klieští a skrutkovačov



ITLG
76

Súprava skrutkových kľúčov

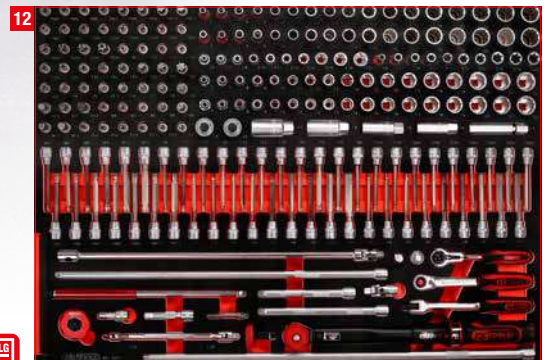

ITLG
221

3/8" súprava nástrčkových kľúčov



ITLG
149

1/2" súprava nástrčkových kľúčov



ITLG
34

Súprava klieští

Integrovaná ochrana hrán

S držiakom na dózy

Stabilné guľôčkové ložiská

Antistatické kolieska s brzdou

Uzamykatelná zámka

1 / 0
Option

6 x XL

M

8 9

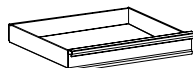

568 x 398 x 75 mm

XL

10 11 12 13 14

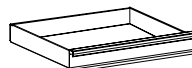

790 x 568 x 75 mm

8 + 9

ITLG
20

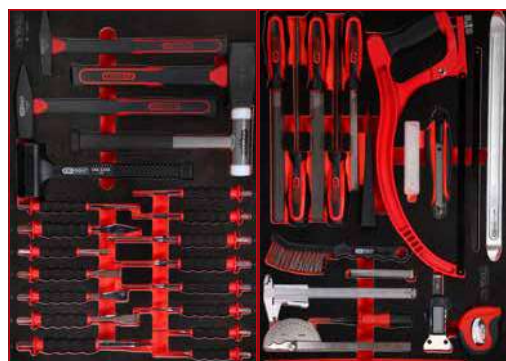

Súprava kladív a sekáčov

ITLG
28

Súprava meracích prístrojov a pilníkov

ČAS NA NOVÉ AUTO?

ECO *Line*



Ďalšie informácie

BEZ NÁRADIA

465,00

Technické údaje:	Eco Line 897.0007	Racing Line 826.0007
Celková nosnosť:	300,0 kg	350,0 kg
Zaťažiteľnosť pre zásuvku: samočinným vtáhovanim a funkciou SOFT-CLOSE:	25,0 kg	30,0 kg
Priemer kolesa:	125,0 mm	125,0 mm
Zaistovač kolies:	✓	✓
S centrálnym zamykaním: samostatné zaistenie:	✗	✓
Výška:	1014,0 mm	976,0 mm
Šírka:	748 mm	788 mm
Hĺbka:	459,0 mm	496,0 mm
Vnútr. rozmer zásuvky:	565 x 395 mm	565 x 395 mm
s polyuretánovou ochranou hrán a rohov:	✗	✓
Štvorcové dierovanie pre diely príslušenstva:	✓	✓
Počet zásuviek:	7	7
hrúbka plechu:	0,8 mm	0,9 mm
uchopovacia lišta:	✓	✓
Vytáhovanie zásuvky:	100 %	90 %
pracovná doska s priehradkami na drobné súčiastky:	✗	✓
Pracovná doska s penovými vložkami:	✓	✗
vedenie zásuvky s guľôčkovými ložiskami:	✓	✓
s bočnou kovovou rukoväťou:	✓	✓

RACING *Line*



Ďalšie informácie

BEZ NÁRADIA

519,00

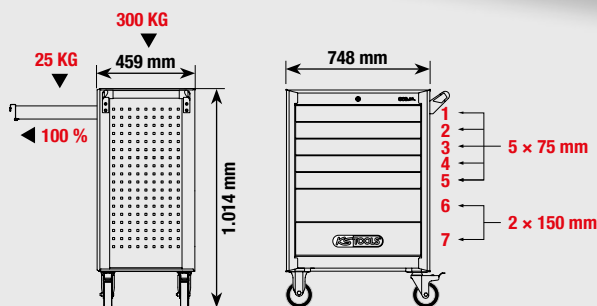
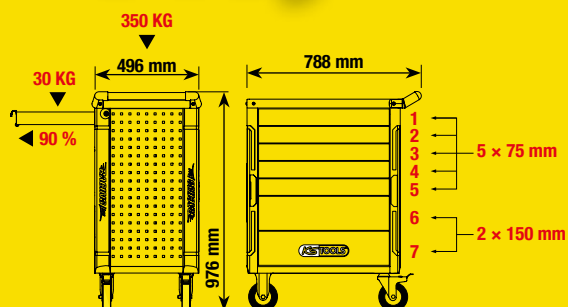

ECO *line*

So 7 zásuvkami a 215
dielnou sadou prémiového
náradia

705,00

897.7215



ŠTARTOVACÍ BALÍK - 215 KS.

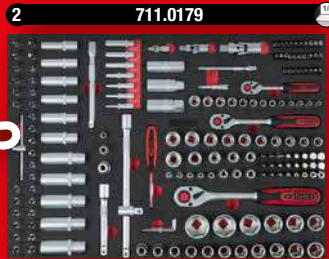
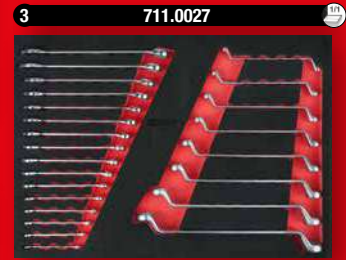

i **215**
Ďalšie informácie

RACING *line*

So 7 zásuvkami a 215
dielnou sadou prémiového
náradia

725,00

826.7215



UNIVERZÁLNY BALÍK - 515 KS.

ECO *line*

So 7 zásuvkami a 515
dielnou sadou prémiového
náradia

910,00

897.7515

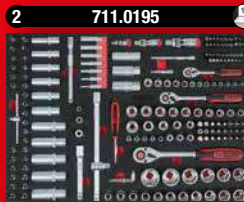
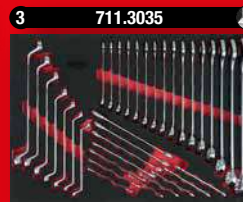

i **515**
Ďalšie informácie

RACING *line*

So 7 zásuvkami a 515
dielnou sadou prémiového
náradia

935,00

826.7515



ECO *line*

So 7 zásuvkami a 598
dielnou sadou prémiového
náradia

1349,00

897.7598

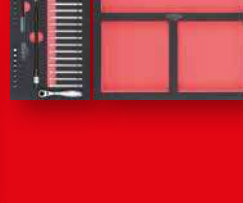
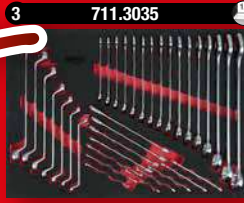
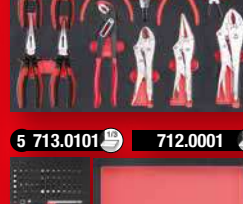
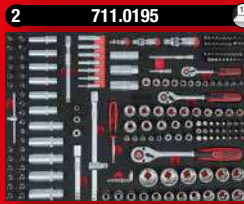

i **598**
Ďalšie informácie

RACING *line*

So 7 zásuvkami a 598
dielnou sadou prémiového
náradia

1400,00

826.7598



PÁN PRSTEŇOV



A	517.0048			8 · 9 · 10 · 11 · 13 · 14 17 · 19 mm	24,00 €
B	517.0052			8 · 9 · 10 · 11 · 12 · 13 · 14 15 · 16 · 17 · 18 · 19 mm	44,00 €
C	517.0043			6 · 7 · 8 · 9 · 10 · 11 · 12 13 · 14 · 15 · 16 · 17 · 18 19 · 20 · 21 · 22 · 24 · 27 30 · 32 mm	114,00 €

od 24,00

- profil FlankTraction
- Otvor zahnutý 15°
- Prstenec zahnutý 15°
- leštené hlavy
- matne satinovaný

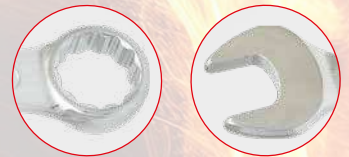

- DIN 3110 / ISO 1085 / ISO 10102 / ISO 3318
- Otvor zahnutý 15°
- brúsené hlavy
- matne satinovaný
- chróm vanád



od 20,00

A	517.0148			6x7 · 8x9 · 10x11 · 12x13 14x15 · 16x17 · 18x19 20x22 mm	20,00 €
B	517.0123			6x7 · 8x9 · 10x11 · 12x13 14x15 · 16x17 · 18x19 20x22 · 21x23 · 24x27 30x32 mm	46,00 €
C	517.0125			6x7 · 8x9 · 10x11 · 12x13 14x15 · 16x17 · 18x19 20x22 · 21x23 · 24x27 25x28 · 30x32 mm	52,00 €



- 12-hran
- DIN 838 / ISO 1085 / ISO 10104 / ISO 3318
- očká zahnuté o 75°
- tenkostenné
- leštené hlavy



od 26,00

A	517.0248			6x7 · 8x9 · 10x11 · 12x13 14x15 · 16x17 · 18x19 20x22 mm	26,00 €
B	517.0222			6x7 · 8x9 · 10x11 · 12x13 14x15 · 16x17 · 18x19 20x22 · 21x23 · 24x27 30x32 mm	52,00 €



NEW

i **1**
 Ďalšie informácie

517.0670	230 mm	42,00 €
517.0675	340 mm	50,00 €
517.0680	450 mm	105,00 €
517.0685	580 mm	160,00 €

od 42,00

TOP SELLER

OBOJSTRANNÁ RAČŇA 4V1

i **1**
 Ďalšie informácie

10 mm
13 mm
17 mm
19 mm

20,00

503.4565 10 x 13 x 17 x 19 mm

L R **72** \times 5°

TOP SELLER

VŠETKO Z JEDNEJ RUKY
 Multifunkčný kľúč

i **1**
 Ďalšie informácie

260 mm
8-17 mm
14-32 mm

35,00

114.0055 8 · 9 · 10 · 11 · 12 · 13 · 14 · 15 · 16 · 17 · 18 · 19 · 20 · 21 · 22 · 23 · 24 · 25 · 26 · 27 · 28 · 29 · 30 · 31 · 32 mm

i **12**
 Ďalšie informácie

72 \times 5°

124,00

503.4665 8 - 9 - 10 - 11 - 12 - 13 - 14 - 15 - 16 - 17 - 18 - 19 mm

TOP SELLER

i **30**
 Ďalšie informácie

12 x

12 x

5/16" x 13 mm
10 mm x 13 mm
1/4" x 10 mm

1/2"
3/8"
1/4"

175,00

503.4960 8 - 9 - 10 - 11 - 12 - 13 - 14 - 15 - 16 - 17 - 18 - 19 mm

NEW

1
Dalšie informácie

Volnobežná račňa:
**PRACUJTE BEZ
OBMEDZENÍ!**

1/4"

75 mm

20,00

912.1485

**STIAHNUŤ,
STIAHNUŤ!**

72 \angle **5°**

2
Dalšie informácie

914.1412

1/2"

305 - 445 mm

1/4"

173 - 223 mm

nastavitelné:
1/4" v 4 krokoch
1/2" v 6 krokoch

36,00

1
Dalšie informácie

914.1205

stupeň: **1 2 3 4 5 6**

nastavitelné v 6 stupňoch

1/2"

26,00

600 MM!

460 - 600 mm

1
Dalšie informácie

52,00

1/2"

760 mm

918.1293

72 \angle **5°**

ŠTÍHLA A SILNÁ!

1/4"

3/8"

1/2"

od 26,00

			Nm	↔	
A	920.1490		1/4"	102	140 mm 26,00 €
B	920.3890		3/8"	325	190 mm 31,00 €
C	920.1290		1/2"	710	245 mm 38,00 €

102 Nm

710 Nm

72 \angle **5°**

57,00

2
Dalšie informácie

920.0002

1

31,00

80° 4.5° 1/4"

935.1490 1/4" 106 g 125 mm **>110 Nm**

2

1

31,00

80° 4.5° 1/4"

935.1495 1/4" 106 g 125 mm **>100 Nm**

1

41,00

96° 3.75° 3/8"

935.3890 3/8" 227 g 199 mm **>365 Nm**

3

**KOMPLETNÝ SERVIS
10 ROKOV
KSTOOLS
ZÁRUKY
S ONLINE REGISTRACIOU**

**ZARUČENÉ:
6 MONSTER
RAČNÍ PRE ŽIVOT!**

1

52,00

100° 3.6° 1/2"

935.1290 1/2" 567 g 275 mm **>950 Nm**

4

STRAŠNE SILNÁ RODINA!

Silnejšie, kusavejšie, robustnejšie, kompaktnejšie, lacnejšie. Lepšie! Šesť dobrých dôvodov pre našich šesť rační Monster! A siedmy dôvod: Na všetky vám dáme 10-ročnú záruku.

1

72,00

100° 3.6° 1/2"

935.1295 1/2" 757 g 425 mm **>950 Nm**

5

1

104,00

100° 3.6° 1/2"

TELESKOPICKY VYSÚVATELNÉ

406 431 457 482 508 533 557 582 607 635 mm **>950 Nm**

935.1285 1/2" 1.280 g 406 - 635 mm

6

i  **9**
 Ďalšie informácie



i  **10**
 Ďalšie informácie

3/8" 

36,00



917.4000  4 - 5 - 6 - 7 - 8 - 9 - 10 - 12 - 14 mm

41,00

3/8" 



 T10 - T15 - T20 - T25 - T27 - T30 - T40 - T45 - T50 - T55 917.4015

i  **50**
 Ďalšie informácie

EXTRA KRÁTKE VYHOTOVENIE

NEW

-  2 - 2,5 - 3 - 4 - 5 - 6
7 - 8 - 9 - 10 mm
-  M5 - M6 - M7 - M8 - M9
M10 - M12
-  T10 - T15 - T20 - T25 - T27
T30 - T40 - T45 - T47 - T50
-  PH1 - PH2 - PH3
-  6 - 10 mm
-  7/35" - 1/4"
5/16" - 3/8"
-  IPR20 - IPR25
IPR27 - IPR30
IPR40 - IPR45
-  IP10 - IP15 - IP20 - IP25
IP30 - IP40 - IP45 - IP50



35,00



911.1850 

i  **19**
 Ďalšie informácie

49,00

NEW











 +  + 











 EPL4 - EPL5 - EPL6 - EPL7 - EPL8 - EPL10 - EPL11 - EPL12 - EPL14
EPL16 - EPL18 - EPL20 - EPL22 - EPL24 - EPL26 - EPL28 - EPL30 - EPL32

 EPL8,8

515.0119

i  **77**
 Ďalšie informácie

-  E 
-  EPL 
-  TX 
-  TB 
-  IP 
-  IPR 

- 5 x  1/4": E4 - E5 - E6 - E7 - E8
- 4 x  3/8": E10 - E12 - E14 - E16
- 4 x  1/2": E18 - E20 - E22 - E24
- 5 x  1/4": EPL4 - EPL5 - EPL6 - EPL7
EPL8
- 4 x  3/8": EPL10 - EPL12 - EPL14
EPL16
- 4 x  1/2": EPL18 - EPL20 - EPL22
EPL24
- 8 x  1/4": T6 - T8 - T10 - T15 - T20
T25 - T27 - T30
- 5 x  3/8": T40 - T45 - T47 - T50 - T55
- 2 x  1/2": T60 - T70
- 7 x  1/4": TB8 - TB10 - TB15 - TB20
TB25 - TB27 - TB30

- 4 x  3/8": TB40 - TB45 - T50 - T55
- 1 x  1/2": TB60
- 7 x  1/4": IP8 - IP10 - IP15 - IP20
IP25 - IP27 - IP30
- 3 x  3/8": IP40 - IP45 - IP50
- 2 x  1/2": IP55 - IP60
- 7 x  1/4": IPR8 - IPR10 - IPR15
IPR20 - IPR25 - IPR27 - IPR30
- 3 x  3/8": IPR40 - IPR45 - IPR50
- 2 x  1/2": IPR55 - IPR60

TOP SELLER



104,00

911.0077   

83,00

1/2"

A **HEX** **B** **RIBE** **C** **XZN** **D** **TORX**

A	911.4510			30		5 - 6 - 7 - 8 - 10 - 12 14 - 17 - 19 mm	83,00 €
B	911.4520			32		M5 - M6 - M7 - M8 M9 - M10 - M12 M13 - M14	83,00 €
C	911.4540			26		M5 - M6 - M8 - M9 M10 - M12 - M14 - M16	83,00 €
D	911.4550			32		T20 - T25 - T27 - T30 T40 - T45 - T50 - T55 T60 - T70	83,00 €

i **20**
Ďalšie informácie

1/2"

10 - 11 - 12 - 13 - 14 - 15
16 - 17 - 18 - 19 - 22 - 24
27 - 30 - 32 mm



62,00

911.0620

SÚPRAVY, DO KTORÝCH SA ZAMILUJETE

od
29,00



A

B

1/4"



4 - 4,5 - 5 - 5,5 - 6 - 7 - 8 - 9
10 - 11 - 12 - 13 - 14 mm

A	917.0648		matné satínovanie		48	29,00 €
B	918.0648		vysoký lesk pochromovaný		48	31,00 €

od
83,00



A

B

1/4" + 1/2"



4 - 4,5 - 5 - 5,5 - 6 - 7 - 8 - 9
10 - 11 - 12 - 13 - 14 - 15 - 16
17 - 18 - 19 - 20 - 21 - 22 - 23
24 - 27 - 30 - 32 mm

A	911.0694		matné satínovanie		94	83,00 €
B	918.0694		vysoký lesk pochromovaný		94	93,00 €

i  **108**
 Další informace



1/4" + 1/2"







 4 - 4,5 - 5 - 5,5 - 6 - 7 - 8 - 9
 10 - 11 - 12 - 13 - 14 - 15 - 16
 17 - 18 - 19 - 20 - 21 - 22 - 24
 27 - 30 - 32 mm

93,00

911.0708

i  **82**
 Další informace

**ŠESTHRANNÁ
 DOPLNKOVÁ SÚPRAVA,
 PALCOVÉ ROZMERY**

NEW





- 5/32" - 3/16" - 7/32"
- 1/4" - 9/32" 5/16"
- 11/32" - 3/8" - 7/16"
- 1/2" 9/16" - 5/8"
- 11/16" - 3/4" - 13/16"
- 7/8" - 9/16" - 5/8"
- 11/16" - 3/4" 13/16"
- 7/8" - 15/16" - 1"
- 1.1/16" 1.1/8"
- 1.3/16" - 1.1/4"



- 5/32" - 3/16" - 7/32"
- 1/4" - 9/32" 5/16"
- 11/32" - 3/8" - 7/16"
- 1/2" 9/16" - 5/8"
- 11/16" - 3/4" - 13/16"
- 7/8" - 9/16" - 5/8"
- 11/16" - 3/4" 13/16"
- 7/8" - 15/16" - 1"
- 1.1/16" 1.1/8"
- 1.3/16" - 1.1/4"

1/4" + 3/8" + 1/2"

90,00

917.0082

ROZŠÍRTE SVOJE MOŽNOSTI

i  **133**
 Další informace

90,00

NEW



 1/4"

-  4 - 4,5 - 5 - 5,5 - 6 - 7 - 8 - 9 - 10
11 - 12 - 13 - 14 mm
-  4 - 4,5 - 5 - 6 - 7 - 8 - 9 - 10 - 11
12 - 13 mm
-  E4 - E5 - E6 - E7 - E8
-       

 3/8"

-  9 - 10 - 11 - 12 - 13 - 14 - 15 - 16
17 - 18 - 19 mm
-  9 - 10 - 11 - 12 - 13 - 14 - 15 - 16
17 - 18 - 19 mm
-  E10 - E11 - E12 - E14 - E16 - E18

 1/2"

-  9 - 10 - 11 - 12 - 13 - 14 - 15 - 16 - 17 - 18
19 - 20 - 21 - 22 - 23 - 24 - 27 - 30 - 32
34 - 36 mm
-  10 - 11 - 12 - 13 - 14 - 15 - 16
17 - 18 - 19 - 22 mm
-  E20 - E22 - E24

 1/4" - 3/8"
 1/2" 50 - 100 - 125 - 250 mm

 1/4" - 3/8"
 1/2"

1/4" + 3/8" + 1/2"

917.0133



Ďalšie informácie

		○ 4 - 4,5 - 5 - 5,5 - 6 - 7 - 8 - 9 - 10 - 11 - 12 13 - 14 mm
1/4"		○ 4 - 5 - 6 - 7 - 8 - 9 - 10 mm
		★ E4 - E5 - E6 - E7 - E8
		⊖ ⊕ ⊗ ⊙ ⊛ ⊜
3/8"		○ 10 - 11 - 12 - 13 - 14 - 15 - 16 - 17 - 18 19 mm
		○ 10 - 11 - 12 - 13 - 14 - 15 mm
		★ E10 - E11 - E12 - E14 - E16 - E18
		○ 10 - 11 - 12 - 13 - 14 - 15 - 16 - 17 - 18 19 - 20 - 21 - 22 - 24 - 27 - 30 - 32 mm
1/2"		○ 16 - 17 - 18 - 19 - 22 mm
		★ E20 - E24
1/4" 5/16"		⊖ ⊕ ⊗ ⊙ ⊛ ⊜
1/4" - 3/8" 1/2"		50 - 100 - 125 - 150 - 250 mm
		● 1,3 - 1,5 - 2 - 2,5 - 3 - 4 - 5 mm
1/4" - 3/8" 1/2"		1/4" - 5/16"
1/4"		

1/4" + 3/8" + 1/2"

917.0795



114,00

PRÍPAD PRE DVOCH!



1/4" + 3/8" + 1/2"

od
181,00

1/4"		○ 4 - 4,5 - 5 - 5,5 - 6 - 7 - 8 - 9 - 10 - 11 12 - 13 - 14 mm
		○ 6 - 7 - 8 - 9 - 10 - 11 - 12 - 13 - 14 15 mm
		⊖ ⊕ ⊗ ⊙ ⊛ ⊜
3/8"		○ 10 - 11 - 12 - 13 - 14 - 15 - 16 - 17 - 18 19 mm
		○ 10 - 11 - 12 - 13 - 14 - 15 mm
		○ 10 - 11 - 12 - 13 - 14 - 15 - 17 - 18 - 19 20 - 21 - 22 - 24 - 27 - 30 - 32 mm
1/2"		○ 17 - 19 - 22 mm
		★
1/4" 5/16"		⊖ ⊕ ⊗ ⊙ ⊛ ⊜
		⊙ ⊛ ⊜
12 x		8 - 9 - 10 - 11 - 12 - 13 - 14 - 15 - 16 - 17 18 - 19 mm
		● 1,3 - 1,5 - 2 - 2,5 - 3 - 4 - 5 mm
1/4" - 3/8" 1/2"		
1/4"		

A	917.0216		matné satinovanie	216	181,00 €
B	918.0216		vysoký lesk pochromovaný	216	197,00 €

VAŠI KLÚČOVÍ POMOČNÍCI PRI PRÁCI

1/4"	4 - 4,5 - 5 - 5,5 - 6 - 7 - 8 9 - 10 - 11 - 12 - 13 14 mm
1/4"	4 - 5 - 6 - 7 - 8 - 9 - 10 mm ✱ E4 - E5 - E6 - E7 - E8
3/8"	10 - 11 - 12 - 13 - 14 - 15 16 - 17 - 18 - 19 mm
3/8"	10 - 11 - 12 - 13 - 14 - 15 mm ✱ E10 - E11 - E12 - E14 E16 - E18
1/2"	16 - 17 - 18 - 19 - 22 mm ✱ E20 - E24
1/4" 5/16"	18 mm
1/4" - 3/8" 1/2"	10 - 11 - 12 - 13 - 14 - 15 16 - 17 - 18 - 19 - 20 - 21 22 - 24 - 27 - 30 - 32 mm
1/4" - 3/8" 1/2"	16 - 17 - 18 - 19 - 22 mm
1/4"	16 - 21 mm
1/4" - 3/8" 1/2"	50 - 100 - 125 - 150 250 mm
1/4"	1,3 - 1,5 - 2 - 2,5 - 3 4 - 5 mm
1/4"	150 mm

1/4" + 3/8" + 1/2"

5°

R

L

72

124,00

TOP SELLER

A	917.0255			225		6-hran + mm	4 - 4,5 - 5 - 5,5 - 6 - 7 - 8 - 9 - 10 - 11 12 - 13 - 14 - 15 - 16 - 17 - 18 - 19 - 20 21 - 22 - 24 - 27 - 30 - 32	124,00 €
B	916.0255			225		12-hran + mm	4 - 4,5 - 5 - 5,5 - 6 - 7 - 8 - 9 - 10 - 11 12 - 13 - 14 - 15 - 16 - 17 - 18 - 19 - 20 21 - 22 - 24 - 27 - 30 - 32	124,00 €

3/4"

15°

R

L

24

od 228,00

A	911.0721			21		6-hran + mm	19 - 21 - 22 - 23 - 24 - 26 - 27 - 29 - 30 - 32 - 35 36 - 38 - 41 - 46 - 50 mm	228,00 €
B	911.0722			21		12-hran + mm	19 - 21 - 22 - 23 - 24 - 26 - 27 - 29 - 30 - 32 - 35 36 - 38 - 41 - 46 - 50 mm	258,00 €
C	911.0751			21		12-hran + palce	3/4" - 13/16" - 7/8" - 15/16" - 1" - 1.1/16" - 1.1/8" - 1.3/16" 1.1/4" - 1.5/16" - 1.3/8" - 1.7/16" - 1.1/2" - 1.5/8" - 1.3/4" - 2"	258,00 €



Ďalšie informácie

1/2"



1/2"		10 - 11 - 12 - 13 - 14 - 15 - 16 - 17 18 - 19 - 20 - 21 - 22 - 24 mm
3 x		16 - 18 - 21 mm
14 x		6 - 7 - 8 - 9 - 10 - 11 - 12 - 13 - 14 15 - 16 - 17 - 18 - 19 mm
2 x		125 - 250 mm
1 x		3/8"Fx1/2"M
1 x		1/2"
5 x		⊖ 3 - 5,5 - 8 mm ⊕ PH1 - PH2
1 x		TB10 - TB15 - TB20 - TB25 - TB30 TB40 - TB45 - TB50
1 x		2 - 2,5 - 3 - 4 - 5 - 6 - 8 - 10 mm
1 x		6 - 24 V
1 x		240 mm
1 x		180 mm
1 x		300 g

917.0047



125,00

NEW

UNIVERZÁLNI GÉNIOVIA!

1/4"		4 - 4,5 - 5 - 5,5 - 6 - 7 - 8 - 9 - 10 11 - 12 - 13 mm
1/2"		10 - 11 - 12 - 13 - 14 - 15 - 16 - 17 19 - 20 - 21 - 22 - 24 - 27 - 30 - 32 mm
12 x		8 - 9 - 10 - 11 - 12 - 13 - 14 - 15 - 16 17 - 18 - 19 mm
2 x		1/4": 100 mm / 1/2": 125 mm
1 x		1/4" / 1/2"
7 x		⊖ 3 - 4 - 5,5 - 6,5 mm ⊕ PH0 - PH1 - PH2
1 x		T8 - T10 - T15 - T20 - T25 - T27 - T30 T40 - T45 - T50
1 x		1,5 - 2 - 2,5 - 3 - 4 - 5 - 6 - 8 - 10 mm
1 x		300 g
1 x		160 mm
1 x		200 mm



od 181,00



1/4" + 1/2"



A



B

A	917.0797		matné satinovanie	97	181,00 €
B	918.0797		vysoký lesk pochromovaný	97	197,00 €



Ďalšie informácie



1/4"	4 - 5 - 5,5 - 6 - 7 - 8 - 9 10 - 11 - 12 - 13 - 14 mm
5 x	8 - 10 - 13 - 17 - 19 mm
1 x	1/4": 100 mm
1 x	1/4"
4 x	3 - 5,5 mm PH1 - PH2
1 x	1/4"
1 x	1/4" \ominus \oplus \otimes \odot \otimes
1 x	1,5 - 2 - 2,5 - 3 - 4 - 5 - 6 - 7 8 - 10 mm
1 x	100 - 500 V
1 x	160 mm
1 x	180 mm
1 x	250 mm
1 x	300 g

917.0062

1/4"



90,00

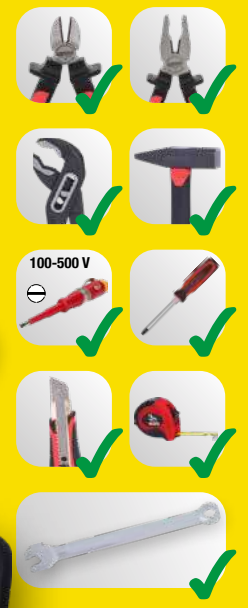

NEW

VŽDY DOBRE VYBAVENÝ



Ďalšie informácie



1/4"	4 - 4,5 - 5 - 5,5 - 6 - 7 - 8 - 9 10 - 11 - 12 - 13 mm
1/2"	14 - 15 - 16 - 17 - 18 - 19 - 20 21 - 22 - 23 - 24 - 25 - 26 - 27 28 - 30 - 32 mm
12 x	6 - 7 - 8 - 9 - 10 - 11 - 12 - 13 14 - 17 - 19 - 22 mm
3 x	1/4": 50 - 100 mm / 1/2": 125 mm
1 x	1/4"
4 x	6,5 - 8 mm PH1 - PH2
1 x	1/4"
1 x	1/4" \ominus \oplus \otimes \odot \otimes
1 x	150 - 250 V
1 x	250 mm
1 x	180 mm
1 x	300 g

911.0688

1/4"

1/2"



197,00



TOP SELLER



Ďalšie informácie



4 x



8 x 8 - 9 - 10 - 11 - 13
14 - 17 - 19 mm



4 - 4,5 - 5 - 5,5 - 6 - 7
8 - 9 - 10 - 11 - 12
13 - 14 mm
1/4"

1/2"

10 - 13 - 14 - 16 - 17
18 - 19 - 20 - 22 - 24
27 - 30 - 32 mm

384,00

1/4" + 1/2"

911.0727



VŠESTRANNÍ POMOČNÍCI



Ďalšie informácie



6 x



4 - 4,5 - 5 - 5,5 - 6 - 7
8 - 9 - 10 - 11 - 12
13 mm
1/4"

1/2"

10 - 13 - 14 - 15 - 16
17 - 18 - 19 - 21 - 22
24 - 27 - 30 - 32 mm

10 x 8 - 10 - 11 - 12 - 13
14 - 15 - 17 - 19 - 22 mm



405,00

911.0649

1/4" + 1/2"



Ďalšie informácie



9 x 1,5 - 2 - 2,5 - 3 - 4 - 5 - 6
8 - 10 mm

9 x TS10 - TS15 - TS20 - TS25
TS27 - TS30 - TS40 - TS45
TS50



1/4" 4 - 4,5 - 5 - 5,5 - 6 - 7
8 - 9 - 10 - 11 - 12
13 mm

1/2" 10 - 11 - 12 - 13 - 14
15 - 16 - 17 - 18 - 19
21 - 22 - 24 - 27 - 30
32 mm

11 x 8 - 9 - 10 - 11 - 12
13 - 14 - 16 - 17 - 19
22 mm

911.0630

1/4" + 1/2"



467,00

NAPÍNAVÍ A VÝKONNÍ!



Ďalšie informácie

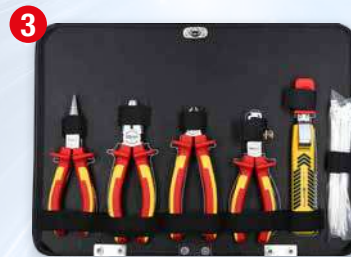

1/4" 4 - 4,5 - 5 - 5,5 - 6 - 7 - 8
9 - 10 - 11 - 12 - 13 mm

1/2" 10 - 11 - 12 - 13 - 14 - 15
16 - 17 - 18 - 19 - 21 - 22 mm

10 x 8 - 10 - 11 - 12 - 13 - 14
15 - 17 - 19 - 22 mm

911.0628

1/4" + 1/2"



405,00



Ďalšie informácie

MOBILITA NADOVŠETKO!

1/4" + 1/2"



1/4"	4 - 5 - 6 - 7 - 8 - 9 - 11 12 - 13 mm
1/2"	10 - 11 - 12 - 13 - 14 - 15 - 16 17 - 18 - 19 - 21 - 22 - 24 mm
10 x	8 - 9 - 10 - 11 - 12 - 13 14 - 16 - 17 - 18 - 19 mm

540,00

911.0735



Ďalšie informácie

TOP
SELLER



119,00



9 - 10 - 11 - 12 - 13 - 14 - 15 - 16 - 17 - 18
19 - 20 - 21 - 22 - 23 - 24 - 26 - 27 - 30 mm

9 - 10 - 11 - 12 - 13 - 14 - 15 - 16 - 17 - 18
19 - 20 - 21 - 22 - 23 - 24 - 26 - 27 - 30 mm



1/2"

515.0065

KOMPETENCIA V KUFRÍKOCCH!



i 99
Ďalšie informácie

**TOP
SELLER**

- 1/4"
- 1/2"



i 99
Ďalšie informácie

**TOP
SELLER**

- 1/4"
- 1/2"



PRSTENCOVÝ KLÚČ S RAČŇOU



- 8 - 9 - 10 - 11 - 12 - 13 - 14
15 - 16 - 17 - 18 - 19 mm



1/4"	4 - 5 - 6 - 7 - 8 - 9 - 10 - 11 - 12 13 - 14 mm
1/2"	13 - 15 - 17 - 18 - 19 - 20 - 21 - 22 24 - 27 - 30 - 32 mm

**ROZHODNITE
SA.
VŽDY JE TO
DOBRA
VOĽBA.**

PRSTENCOVÉ KLÚČE



- 8 - 9 - 10 - 11 - 12 - 13 - 14
15 - 16 - 17 - 18 - 19 mm



623,00



540,00

918.0100

918.0200

KALIBROVANÉ PRE BUDÚCNOSŤ!



Ďalšie informácie

JE NAVŽDY!



Infinitool



dodávka v plastovom kufríku

SERVICE REMINDER



START 1 6 12 MONTH



KALIBRÁCIA PO 12 MESIACHOCH

Pri prvom použití sa spustí pripomienka servisu. Po 12 mesiacoch sa automaticky zobrazí červená stupnica, ktorá signalizuje, že váš momentový kľúč si vyžaduje kalibráciu.



od **59,00**

Stupnica s lupou

Mikrometrická stupnica

		Nm	Delenie Nm	Lbf-ft		
516.9002		1/4"	1-5	0,02	0,8 - 3,6	59,00 €
516.9012		1/4"	5-25	0,10	0,8 - 18	65,00 €
516.9022		3/8"	10-50	0,10	4 - 37	69,00 €
516.9032		1/2"	20-100	0,10	8 - 75	75,00 €
516.9042		1/2"	20-200	1,00	15 - 150	79,00 €
516.9072		1/2"	60-320	1,00	45 - 236	95,00 €
516.9082		1/2"	80-420	1,00	60 - 310	105,00 €
516.9090		3/4"	110-550	2,00	75 - 405	495,00 €
516.9093		3/4"	150-750	5,00	150 - 550	575,00 €
516.9095		1"	200-1000	5,00	220 - 730	745,00 €



Ďalšie informácie

SERVICE REMINDER

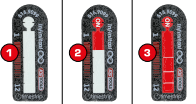

Infinitool

175,00

20-100 Nm

1X A NA CELÝ ŽIVOT, PROSÍM!



516.9110 14 x 18 mm 17 - 22 - 24 - 26 - 27 - 29 mm



Ďalšie informácie

SERVICE REMINDER



Infinitool

165,00

20-200 Nm

NAVŽDY PRESNÉ!



516.9105 14 x 18 mm 13 - 15 - 16 - 17 - 18 - 19 - 21 mm

od 20,00

DLHÝ A B

A	151.4420			<ul style="list-style-type: none"> 1,5 - 2 - 2,5 - 3 - 4 5 - 6 - 8 - 10 mm 	20,00 €
B	151.5210			<ul style="list-style-type: none"> T10 - T15 - T20 T25 - T27 - T30 T40 - T45 - T50 	25,00 €

911.3030

TORION power

10,50

+30%

1 x		1/4"
1 x		1/4"
4 x		3 - 4 - 5 - 6 mm
4 x		PH1 - 2 x PH2 - PH3
4 x		PZ1 - 2 x PZ2 - PZ3
4 x		3 - 4 - 5 - 6 mm
7 x		T10 - T15 - T20 - T25 - T27 - T30 - T40
7 x		TB10 - TB15 - TB20 - TB25 - TB27 - TB30 - TB40

108

TORION power

31,00

+30%

918.3108

1/4"

6x	4 - 5 - 6 mm
6x	PZ1 - PZ2 - PZ3
6x	PH1 - PH2 - PH3
6x	4 - 5 - 6 mm
6x	T10 - T15 - T20 - T25 - T30 - T40

32

TOP SELLER

46,00

918.3010

1/4"

4 x	3 - 4 - 5 - 6 mm
4 x	PH1 - 2 x PH2 - PH3
4 x	PZ1 - 2 x PZ2 - PZ3
4 x	3 - 4 - 5 - 6 mm
7 x	T10 - T15 - T20 - T25 - T27 - T30 - T40
7 x	TB10 - TB15 - TB20 - TB25 - TB27 - TB30 - TB40

-22,1%

-49%

208

41,00

911.2008

1/4"

1/4"		1/4": 205 mm
138 x	25 mm	
29 x	50 mm	
18 x	75 mm	
20 x	4 - 5 - 6 - 7 - 8 - 9 - 10 - 11 - 12 - 13 mm	
	5/32" - 3/16" - 7/32" - 1/4" - 9/32"	
	5/16" - 11/32" - 3/8" - 7/16" - 1/2"	
1 x	1/4": 50 mm	
1 x	1/4"	

25 mm

50 mm

75 mm

NEW

Ďalšie informácie

1/4"

80 mm

5,00

159.1171

NEW

Ďalšie informácie

1/4"

100 mm

7,50

159.1172

od **10,50**

1/4"

A	159.2025	6 v 1 Mini skrutkovač s račňou	10,50 €
B	159.2035	Račňový bitový skrutkovač 12v1	15,00 €

TOP SELLER

6 IN ONE

110 mm

12 IN ONE

240 mm

- 4 - 5 mm
- PH1 - PH2
- PZ1 - PZ2

- 4 - 5 - 6 mm
- PH1 - PH2 - PH3
- 3 - 4 - 5 mm
- T15 - T20 - T25

NEW

Ďalšie informácie

1/4"

80 mm

10,00

159.1176 Dvojitý držiak na bity s rukoväťou v tvare T

NEW

Ďalšie informácie

1/4"

210 mm

5,00

159.1174 Predĺženie pre držiak na bity

NEW

Ďalšie informácie

200 - 400 mm

1/4"

15,00

159.1175 teleskopický držiak bitov s rukoväťou v tvare T

NEW

Štvorhranná rukoväť v tvare T

od **5,00**

140 mm

300 mm

A	151.1111	1/4" krátky	5,00 €
B	151.1112	1/4" dlhý	7,50 €

ERGOTORQUE *plus*

pochromovaný s hnedým hrotom

s označením profilu na rukoväti

od 10,50

A	159.0005			5		4 - 5,5 - 6,5 mm PH1 - PH2	10,50 €
B	159.0030			6		T10 - T15 - T20 T25 - T30 - T40	20,00 €
B	159.0040			6		TB10 - TB15 - TB20 TB25 - TB30 - TB40	20,00 €

39

Ďalšie informácie

TOP SELLER

6 x			3 - 4 - 5,5 - 6,5 8 - 10 mm	7 x			2 - 2,5 - 3 - 4 - 5 6 - 8 mm
5 x			PH0 - PH1 - PH2 PH3 - PH4	7 x			TB10 - TB15 - TB20 TB25 - TB27 - TB30 TB40
4 x			PZ0 - PZ1 - PZ2 PZ3	7 x			T10 - T15 - T20 T25 - T27 - T30 T40
1 x			6 mm	1 x			1/4"
1 x			PH2	1 x			205 mm

53,00

159.0100

13

Ďalšie informácie

TOP SELLER

priechodná čepeľ

5 x			3,5 - 5,5 - 7 - 8 - 10 mm
5 x			PH0 - PH1 - PH2 - PH3 - PH4
1 x			6 mm
1 x			PH2
1 x			1/4"

70,00

151.1150

3

Ďalšie informácie

NEW

EXTRA DLHÉ

6 mm

PH2

T15

450 mm

20,00

159.1270

VŠETKO PRE NITY. DVE HLAVNÉ CENY!



Nity (hliník)



Nity (ocel)



Matica

		A	B
		150.9805	150.9630
	v kufrí	✓	✓
	dĺžka mm	260	510
	nožnice na plech	✓	✗
	obsluha jednou alebo dvomi rukami		
	M10	✓	✓
	M8	✓	✓
	M6	✓	✓
	M5	✓	✓
	M4	✓	✓
	M3	✓	✓
	Oceľ 4,8 mm	✓	✓
	Oceľ 4,0 mm	✓	✓
	Oceľ 3,2 mm	✓	✓
	Oceľ 2,4 mm	✓	✓
	Hliník 6,4 mm	✓	✓
	Hliník 4,8 mm	✓	✓
	Hliník 4,0 mm	✓	✓
	Hliník 3,2 mm	✓	✓
	Hliník 2,4 mm	✓	✓



260 mm

A



15

Ďalšie informácie

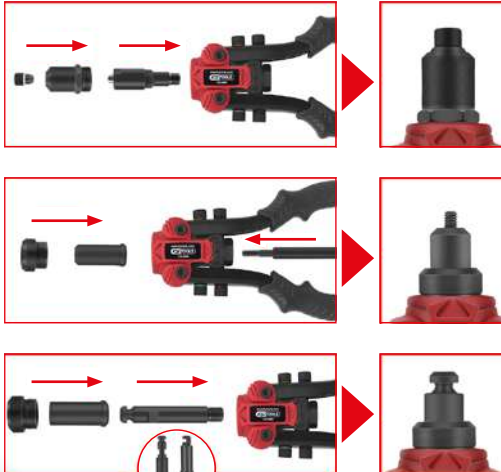



70,00

150.9805



510 mm

B



17

Ďalšie informácie





181,00

150.9630



Ďalšie informácie

EXAKTNE A PRESNE: VŠETKO JE VECOU NASTAVENIA!

NEW



od
10,00

	← →	⚙️		
115.2017	178 mm	7"	18	10,00 €
115.2018	250 mm	10"	25	15,00 €
115.2019	305 mm	12"	30	17,50 €
115.2021	407 mm	16"	28	27,50 €



Ďalšie informácie

CrV DIN 5254 A DIN 5254 B DIN 5256 C DIN 5256 D



Ďalšie informácie



A 19 - 60 mm

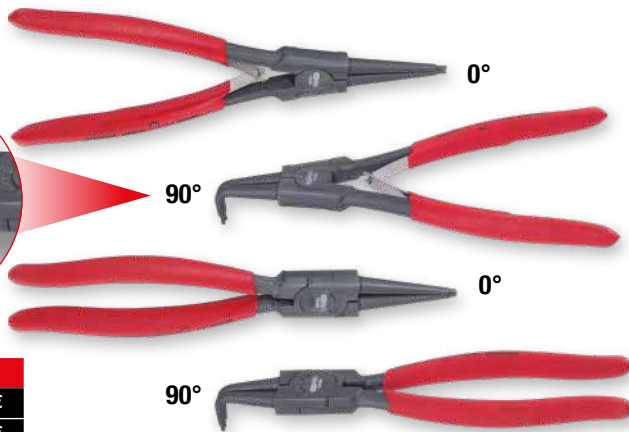

B 40 - 100 mm

od
95,00

	⊕ ⊖	← →		
A	119.2055	19 - 60 mm	160 mm	95,00 €
B	119.2060	40 - 100 mm	230 mm	99,00 €



Ďalšie informácie

vrátane rýchleho zaistovania

TOP
SELLER



5V1

15,00



550.1145

← 172 - 640 mm →

i **4**
 Ďalšie informácie

10,50

550.1045 45° 135° 0° 90°

i **9**
 Ďalšie informácie

20,00

**TOP
SELLER**

550.1070 45° 135° 0° 90° 45° 90° 0°

i **11**
 Ďalšie informácie

**ISO
BUTAN**

200 mm

Piezo

20 mm 33 mm Ø 1,6 mm Ø 3,5 mm Ø 4,5 mm Ø 5 mm 30 mm

95 mm 95 mm Ø 40 mm

960.1160 Súprava mikrospájok

31,00

i **283**
 Ďalšie informácie

220 mm

Ø 0,5 - 6 mm Ø 0,5 - 6 mm Ø 0,5 - 10 mm

Ø 6,50 / 5,41 / 1,72 mm Ø 0,5 - 4 mm

Ø 1,0 - 3,2 mm

115.1400

176,00

i **5**
 Ďalšie informácie

Regulácia teploty:
 1≈50°C / 2≈100°C / 3≈200°C / 4≈350°C / 5≈550°C / 6≈650°C

260 mm

1 2 3 4 5 6

1 max. 450°C
 2 max. 650°C

Oblasti použitia:
 odstraňovanie farby, spájkovanie rúr,
 zmršťovanie PVC, zváranie a ohýbanie
 plastov, sušenie, topenie atď.

31,00

960.1190

i **1**
 Ďalšie informácie

IP 34

15+1 m

3x 1,5 mm²

230 V
50 Hz

1000/3000 W

10 A

180°

140,00

150.4217

i **1**

Ďalšie informácie

138 x 69
x 31 mm

342

9 V

Data Hold

69 mm

138 mm

20,00

- meranie jednosmerného a striedavého napätia
- meranie jednosmerného a striedavého prúdu
- meranie odporu
- test diód (s akustickým signálom)

- skúška prechodnosti (s akustickým signálom)
- funkcia Data Hold
- kontrolka batérie

150.1495

i **1**

Ďalšie informácie

MULTITALENT

LEN TELEFONOVANIE ZATIAŤ NIE JE MOŽNÉ.

TOP
SELLER

143 x 70
x 16 mm

119

AAA

Data Hold

+ NCV

143 mm

70 mm

16 mm

AUTOMATIC DIGITAL MULTIMETER

Nie Popis

1	Vypínač
2	Prepínač funkcií
3	Kapacitný spínač
4	Vypínač osvetlenia
5	Displej LCD
6	Oblasť snímača NCV
7	Testovacie vodiče

52,00

USB-A

USB-C

Symbol	Popis
	DC napätie
	Striedavé napätie
	Indikátor automatického vypnutia
	Indikátor slabej batérie
	Diódový režim
	Priechod
	Kapacita
	Pomer merača výkonu
	Funkcia uchovávanía údajov
	Jednotka napätia: volt, milivolt
	Jednotka kapacity
	Jednotka odporu
	Bezkontaktná indukcia napätia
	Testovanie živých vedení
	Jednotka frekvencie
	Celzia/Fahrenheita

NCV
 3 COLOUR ANALOG BAR
 BUZZER ALARM

150.1765

i  **1**
 Ďalšie informácie



24,00

300.0510

i  **1**
 Ďalšie informácie

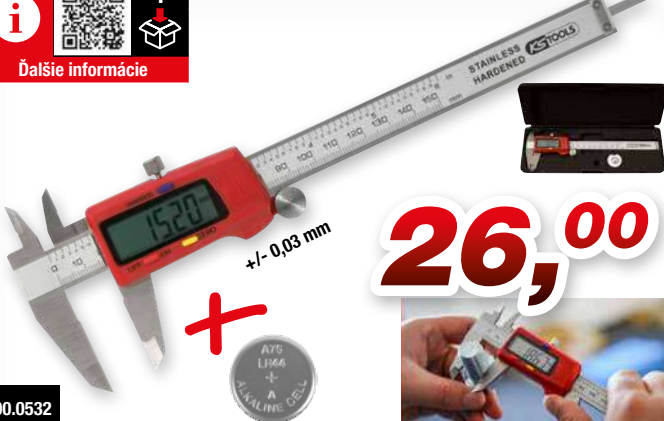

26,00

300.0532

i  **1**
 Ďalšie informácie

**ZAMERANÉ NA PRESNOSŤ:
 INFRAČERVENÝ TEPLOMER,
 -38° - 520°C**



52,00

150.3040

i  **4**
 Ďalšie informácie

59,00



Refraktometer - optický testovací prístroj pre batériovú kvapalinu a nemrznúcu zmes

550.1290

i  **4**
 Ďalšie informácie

70,00



AJ PRE ADBLUE®!



Refraktometer - optický skúšobný prístroj na batériovú kvapalinu, nemrznúcu kvapalinu a prísady AdBlue®

550.1285

i **4**
 Ďalšie informácie

11 x 115 mm
 15 x 185 mm
 18 x 320 mm
 18 x 470 mm

20,00

911.8100 **Súprava montážnych pák**

i **4**
 Ďalšie informácie

XL

900 mm
 600 mm

0°
 45°
 75°
 90°

149,00

911.8410 **Súprava montážnych pák**

i **22**
 Ďalšie informácie

Súprava 2 + 3 ramenných univerzálnych hydraulických sťahovák

- malé nebezpečenstvo zošmyknutia vďaka automaticky zatváreným ramenám sťahováka
- možných 8 variantov sťahováka
- extrémne robustné vreteno s indukčne tvrdým závitom
- vynaloženie malej sily
- špeciálna nástrojová ocel

317,00

700.1200

10t.

20 - 35 - 85 mm
 235 mm
 185 mm
 225 mm
 170 mm
 120 mm
 Ø max. 100 mm

10 t, AG 1.1/2" x 166

NAŠE SÚPRAVY PRE NÚDZOVÉ PRÍPADY

i **13**
 Ďalšie informácie

Rescue power

TOP SELLER

83,00

0 % ✓ 85 % ✓

na povolovanie a odskrutkovanie uviaznutých matic a skrutiek s poškodenými hlavami alebo „pretočených“ hlav

Vrátane 3/8" 1/2"

8 - 9 - 10 11 - 12 - 13 - 14 - 15 - 16 - 17 - 18 - 19 mm **3/8"**

913.3930

i **7**
 Ďalšie informácie

Rescue power

TOP SELLER

93,00

očka zahnuté o 45°

6x7 - 8x9 - 10x11 - 12x13 - 14x15 - 16x17 - 18x19 mm

517.1555



Ďalšie informácie

17,00



- na skrutky M3 - M24
- umožňuje vyskrutkovanie odtrhnutých skrutiek a svorníkov
- kuželovitá špirála
- v stabilnom plastovom boxe

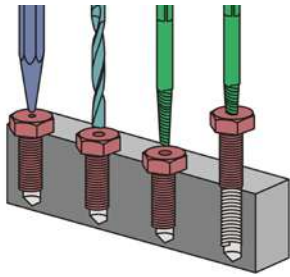

150.1330 Súprava vyvrtávačov skrutiek



Ďalšie informácie

TAKTO SA NIKDY NEZBLÁZNITE.

TOP SELLER

TORION power

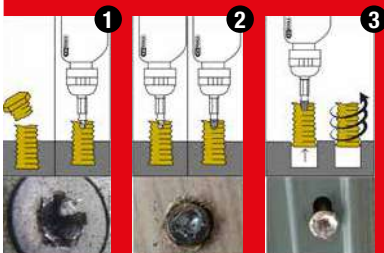

46,00



- 9 x TE10 - TE15 - TE20 - TE25 - TE27 - TE30 - TE40 - TE50 - TE55
- 9 x 1,5 - 2 - 2,5 - 3 - 4 - 5 - 6 - 8 - 10 mm
- 7 x 1,5 - 2 - 2,5 - 3 - 4 - 5 - 6 mm
- 7 x T10 - T15 - T20 - T25 - T27 - T30 - T40

1/4" + 10 mm

150.7060 Súprava vyťahovákov na skrutky TX a skrutky s vnútorným šesťhranom



Ďalšie informácie

41,00

- rozsiahla súprava
- na odstraňovanie odlomených závitových čapov a skrutiek
- žiadne poškodenie závitů
- len malé rozšírenie závitových čapov vďaka špeciálne profilovaným vyvrtávacím kolíkom

Führungshülse drill guide	Hülse Innen- Ø mm guide	vorböhren Ø mm pre-drilling	aufbohren re-drilling	Stift pin	Art.Nr. Stift No. Pin	Mutter D nut D	Art.Nr. Mutter nut D	Stift + Mutter pin + nut
150.0501	4,0 / 3,2	3,2	-	3,2	150.0521	SW 10	150.0511	150.0511S
150.0502	4,8 / 3,2	3,2	-	3,2	150.0521	SW 10	150.0511	150.0511S
150.0503	4,8 / 3,2	3,2	4,8	4,8	150.0522	SW 11	150.0512	150.0512S
150.0504	4,8 / 3,2	3,2	4,8	4,8	150.0522	SW 11	150.0512	150.0512S
150.0505	6,0 / 4,8	4,8	6,4	6,4	150.0523	SW 13	150.0513	150.0513S
150.0506	7,0 / 4,8	4,8	6,4	6,4	150.0523	SW 13	150.0513	150.0513S
150.0507	7,0 / 4,8	4,8	8,0	8,0	150.0524	SW 14	150.0514	150.0514S
150.0508	7,0 / 4,8	4,8	8,7	8,7	150.0525	SW 17	150.0515	150.0515S
150.0509	9,0 / 6,5	6,4	8,7	8,7	150.0525	SW 17	150.0515	150.0515S
150.0510	9,5 / 6,5	6,4	8,7	8,7	150.0525	SW 17	150.0515	150.0515S

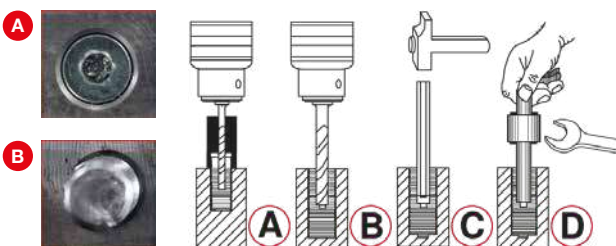

150.1305 M5 - M6 - M8 - M10 - M12 - M14 - M16 Súprava na odvrátavanie zo závitov

i **7**
 Ďalšie informácie

52,00

1/2" 21 mm

M5 M6 M7 M8 M10 M12 M14

152.1101 M5 - M6 - M7 - M8 - M10 - M12 - M14 Vyrvtávač podporných čapov - súprava

i **12**
 Ďalšie informácie

26,00

Mikro jemný úplet

	Veľkosť	Obsah
310.0490	7	12 párov
310.0491	8	12 párov
310.0470	9	12 párov
310.0475	10	12 párov
310.0480	11	12 párov

EN388
 4131X

i **100**
 Ďalšie informácie

PERFECT GRIP

z nitrilu

SENSITIVE

NEW

8 mil

VŠETKO V RUKÁCH!

ABSOLÚTNE ODOLNÉ PROTI ROZTRHNUTIU, S ÚČINKOM PROTI POTENIU

20,00

	Veľkosť	Obsah
310.0461	S	100 kus
310.0462	M	100 kus
310.0463	L	100 kus
310.0464	XL	100 kus

CE 2777
 EN ISO 374-1:2016+A1:2018

S = 80±5 mm
 M = 95±10 mm
 L = 110±10 mm
 XL = 120±10 mm

i **1**
 Ďalšie informácie

NEW

100 mm 160 mm 250 mm

4x U

10,00

Zásobník na rukavice, magnetický

160.0035

i **1**
 Ďalšie informácie

EN 379 1/1/1/2

EN 175

310.0195

Technické údaje:

Výber farby: plynulo regulovateľné podľa DIN 9-13
 Štandardné nastavenie svetla: DIN 4

Prepínacia reakčná doba: 1/25.000 s
 0,2 - 0,8 s oneskorenie (nastaviteľné)

Ochrana proti UV/IČ: podľa EN169 / až DIN 16
 Prevádzková teplota: -5 °C až + 55 °C
 Skladovacia teplota: -20 °C až + 70 °C

Napájanie prúdom: lítiová batéria + solárne články

Výška: 220 mm
 Šírka: 200 mm
 Dĺžka: 295 mm
 Hmotnosť: 480 g
 Rozmery kazety: 100 x 90 x 10 mm
 Priehľadové sklo: 100 x 50 mm

52,00

i **1**
 Ďalšie informácie

Univerzálny tlakový rozprašovač

- z kvalitného polyetylénu
- pre rôzne chemikálie, ako napr. pracie prostriedky, rozpúšťadlá a čistiace prostriedky atď.
- nevhodný pre čističe brzd
- striekacia hlava z mosadze je nastaviteľná a zablokovateľná
- tesnenia z Viton®u
- vhodný pre prácu dole hlavou

360°

! nevhodný pre čističe brzd

150.8251	1 L	15,00 €
150.8252	2 L	20,00 €

od 15,00

i **1**
 Ďalšie informácie

VYŽARUJE SPOĽAHLIVOSŤ!

TOP SELLER

0,25 L

115 mm

250 mm

Aluminium

52,00

150.8272

i **16**
 Ďalšie informácie

5x 12 mm

5x 16 mm

5x 20 mm

145 mm

13,00

907.2255 **Súprava škrabiek na drážky**

i **27**
 Ďalšie informácie

5x 19 mm

145 mm

145 mm

20,00

907.2200 **Súprava nožov a škrabiek**

od 11,00

Vreckový nožik s aretáciou

A	907.2105		1	190 x 25 mm	11,00 €
B	907.2190		1	220 x 28 mm	12,00 €

A **190 mm** **B** **220 mm**



INŠPEKČIE VO VYSOKOM ROZLIŠENÍ!

WiFi súprava obrazových osciloskopov s \varnothing 5,5 mm 0° HD sonda prednej kamery



41,00

HD



6 stmievaťelných mini LED žiaroviek

\varnothing 5,5 mm

550.7560



V HLAVNEJ ÚLOHE:

KVALITA OBRAZU!

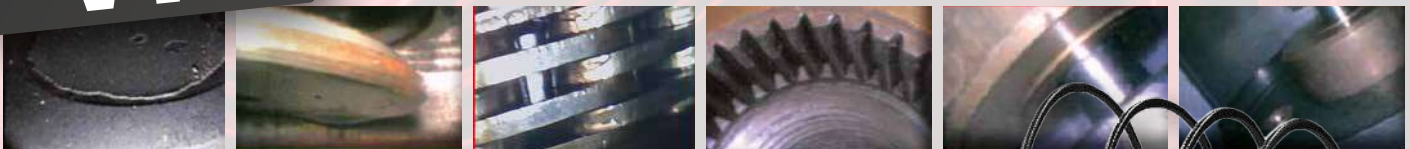

Nerezové puzdro
Skrutková prípojka
pre príslušenstvo

Korunkový dizajn
(ochrana +
optimálne
čistenie)

Kamera
Šošovka
LED dióda
Nerezové puzdro
s vonkajším závitom
Zafírové sklo

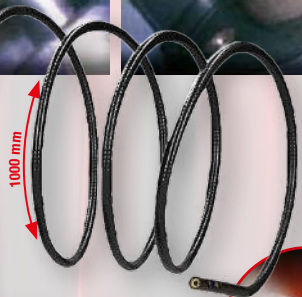

Pripojka sondy

HD

311,00



6 stmievaťelných mini LED žiaroviek

\varnothing 4,5 mm

\varnothing
4,5 mm

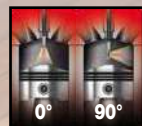

$0^\circ + 90^\circ$

311,00 €

550.7530



\varnothing
4,5 mm

$0^\circ + 90^\circ$

311,00 €



Magnet

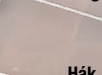

Hák



Ďalšie informácie

HD



Ø
3,9 mm

6 stmievateľných mini LED žiaroviek



IP 67

AVI
1280 x 720

JPG

150 mm

-10°/+60°C

**TOP
SELLER**



180°

180°

Prípojka sondy

USB 2.0

microSD

3000 mAh
Li-polymer



**HVIEZDA
KAŽDÉHO FILMU!**

467,00

**HODNÝ
OSCARA**

+ 32 GB

Súprava HD obrazových osciloskopov s Ø 3,9 mm
180° a 0° HD sonda prednej kamery, ohybný PVC kryt

550.7550



113.1500 Hasák rohový 45°



1.1/2"

270 mm

39,00



104.5060

Steel

Račňový trubkorez
Ø 12 - 35 MM

41,00



70 mm

180 mm

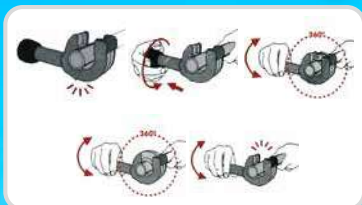

104.5050

Steel

Račňový trubkorez
Ø 28 - 67 MM

135,00



110 mm

250 mm



116.1050

1

2

3

4

5

6

FUGENFIX súprava silikónových škrabákov a odtáhačov

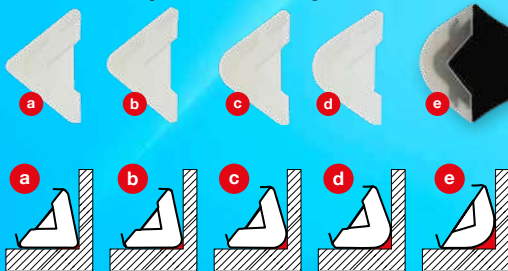

8,00

FUGENFIX®



130.3000

TOP
SELLER



10 mm - 3/8"
12 mm
13 mm - 1/2"
17 mm - 3/4"
22 mm - 1"
90 mm
270 mm

KAŽDÁ
ÚROVEŇ JE
ZÁSAHOM DO
ČIERNEHO

Súprava univerzálnych
stupňových kľúčov 3/8" - 1"

20,00



116.2000

Ventilfix

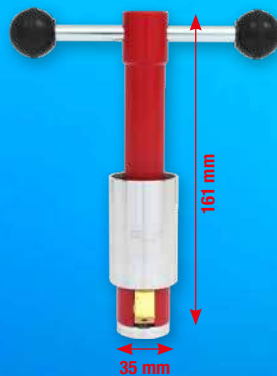

161 mm

35 mm

60,00



130.0300

TOP
SELLER

Súprava nástrčkových kľúčov so
štvorhranom na chladiacu sústavu a
klimatizáciu

111,00



1 x 1/4" - 5/16" - 8,5 - 3/8" 13 mm
10 x 1/4"
3,4 - 4 - 4,5 - 5 - 6,7 - 8 - 9 - 10 mm - 1/4"
3 x 1/4": 7 - 8 - 10 mm

1 x 1/4" 125 mm
1 x 1/4" 150 mm
1 x 1/4"



1/4"

5/16"

9,5 mm

13 mm

8,5 mm





903.5902

Univerzálny kartušový
spájkovací prístroj s
piezo-zapaľovaním

26,00



Piezo



116.2050

Súprava na montáž umývadla

1 x		M8 / M10
3x		9 x 185 mm - 10 x 185 mm - 13 x 185 mm
1 x		
1 x		3/4"

177,00



116.2030

Kombinovaná súprava frézy pre
oblasť sanity

- bezproblémové zaskrutkovanie a vyskrutkovanie 1/2" predĺženia kohútov pri konečnej montáži v oblasti sanity
- predĺženia kohútov sa frézujú tesne pri stene
- pripájacie ventily sa dajú zaskrutkovať a vyskrutkovať aj v ťažko dostupných oblastiach
- v stabilnom plastovom kufríku



1 x		1/2"
1 x		12 x 110 mm
1 x		
1 x		



139,00



850.0300

Univerzálna taška na náradie
SMARTBAG



77,00



116.6200

35,00

PERFECT
10!

TOP
SELLER



Križový kľúč pre sanitu

10 FUNKCIÍ

4x vnútorný závit pre závesné skrutky M6, M8, M10 + M12 na montáž a demontáž pripavení umývadiel

4x vonkajší šesťhran 3/8", 1/2", 3/4" + 1" na montáž a demontáž ventilov na vykurovacích telesách a vratných skrutkových spojov

2x vnútorný štvorhran pre rúrkové zátky 3/8" + 1/2"

Dodávka bez
montážneho
materiálu



Ďalšie informácie



eMONSTER



1/4"



max 6 Nm



max 4 Nm



max 2 Nm



36,00



USB-C

vrát. 25 bitov

515.3600 eMONSTER súprava akumulátorového tyčového skrutkovača

NO PROSÍM: TO NAJLEPŠIE PRE BITY!

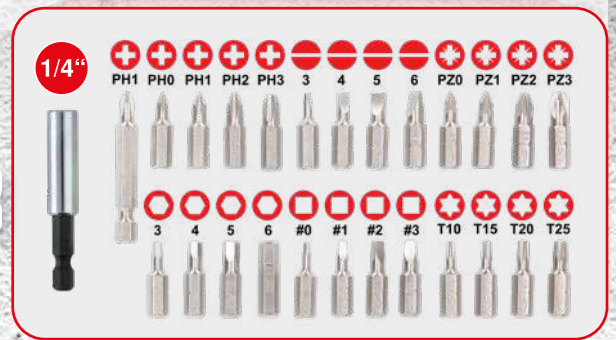

vrát. 25 bitov



Ďalšie informácie

eMONSTER

Zariadenie 2v1 s vyváženým pomerom medzi výkonom a veľkosťou, ideálne pre prácu nad hlavou a v stiesnených priestoroch.



praktický indikátor stavu nabitia batérie s 3 LED diódami

41,00

2 V 1



magnetické bitové uchytanie



1/4"

predvoľba krútiaceho momentu nastaviteľná v 10 krokoch

integrované svetidlo



515.6500 eMONSTER súprava akumulátorového skrutkovača na bity





Ďalšie informácie

515.3990

MULTITALENT

eMONSTER Súprava akumulátorového multifunkčného náradia s 50 dielmi príslušenstva

eMONSTER



1 Vrtanie

1x Ø 3 mm

2 Čistenie

1x

3 Brúsenie

1x Ø 6 mm

4x

23x

Ø 20 mm

4 Gravírovanie

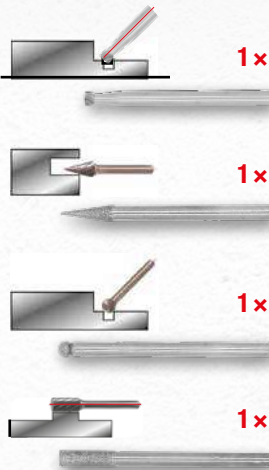

5 Rezanie

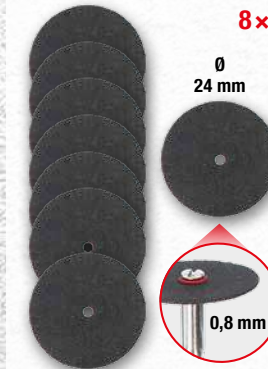

6 Leštenie

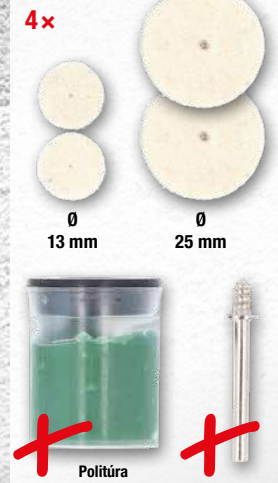

52,00



Ďalšie informácie

NA DOKÚPENIE



515.3992

Súprava príslušenstva, 50-dielna

10,50



Kompaktná a robustná konštrukcia:

Vďaka kvalitným plastom a pevným skrutkovým spojom ponúka akumulátor mimoriadne dobrú ochranu pred mechanickými vplyvmi.



18 V akumulátorový systém eMONSTER

Výkonný 18V akumulátorový systém eMONSTER je určený pre celý rad profesionálnych akumulátorových elektrických náradí. Všetky zariadenia je možné používať s jedným akumulátorovým systémom. Ponuka je široká, ale stále ju rozširujeme. S týmto akumulátorovým systémom je možné používať aj každé nové zariadenie. Tento batériový systém preto môžete používať dlhé roky a doplniť ho o 18V zariadení eMONSTER - nemusíte používať žiadne iné akumulátory.



Odvod tepla:

Vďaka rebrovej štruktúre je teplo odvádzané do okolitého vzduchu ako u chladiča.



Dodatočná ochrana pre dlhú životnosť akumulátora:

- **Prepätová ochrana:**
Ochrana proti neprípustným zdrojom vysokého napätia
- **Nízkonapäťová ochrana:**
Ochrana proti hlbkovému vybitiu počas prevádzky
- **Ovládanie teploty:**
Súhra zariadenia a akumulátora na zabránenie preťaženiu akumulátora



Aktívne chladenie vzduchom:

(iba s 8,0 Ah rýchlonabíjačkou). Integrovaný ventilátor 8,0 Ah rýchlonabíjačky nepretržite dodáva chladný čerstvý vzduch počas nabíjania pre maximálne možné zníženie tepla vznikajúceho v akumulátore a nabíjačke. Tento šetrný proces nabíjania výrazne zvyšuje životnosť akumulátora.



Optimalizované usporiadanie článkov:

Jednotlivé články sú vďaka rúrkovej konštrukcii zatlačené do plastu odvádzajúceho teplo. Tým sa vytvorí pevný kontakt medzi článkom a plastom odvádzajúcim teplo. Už tu nie je žiadna izolačná vrstva vzduchu, ktorá znižuje odvod tepla.



Súprava bitov 1/4" TORSIONpower v dizajne akumulátora eMONSTER, 32-dielna



10,50

1 x		1/4"
1 x		1/4"
4 x		3 - 4 - 5 - 6 mm
4 x		PH1 - 2 x PH2 - PH3
4 x		PZ1 - 2 x PZ2 - PZ3
4 x		3 - 4 - 5 - 6 mm
7 x		T10 - T15 - T20 - T25 - T27 - T30 - T40
7 x		TB10 - TB15 - TB20 - TB25 - TB27 - TB30 - TB40



možnosť pripojenia a aretácie k 18 V zariadeniam eMONSTER ako fiktívny akumulátor

TOP
SELLER

eMONSTER súprava bezuhlíkového akumulátorového
vrtacieho skrutkovača



eMONSTER súprava bezuhlíkového akumulátorového
príklepového vrtacieho skrutkovača

TOP
SELLER

MINI



166,00

Max. krútiaci moment: 40 Nm
Pohon: 10 mm rýchlopínadlo vrtáka

515.6400

VRÁTANE



napätie akumulátora: 18,0 V
Max. nabíjaci prúd: 3 A

napätie akumulátora: 18,0 V
Akumulátorová technológia: Litium-iónový
Kapacita akumulátora: 2,0 Ah

dodávka vrátane dvoch 2,0 Ah
akumulátorov a 3 A rýchlonabíjačky



197,00

Max. krútiaci moment: 60 Nm
Pohon: 13 mm kovové rýchlopínacie zariadenie vrtáka Röhm

515.6300

VRÁTANE



TOP
SELLER

eMONSTER súprava 1/2"
bezuhlíkového akumulátorového
nárazového utáhovača



eMONSTER súprava
akumulátorovej uhlovej
brúsky

TOP
SELLER



predvoľba krútiaceho momentu
nastaviteľná v 3 krokoch

1/2 690 N•m

OFFNEN

2/2 690 N•m

OFFNEN STOP

Aretácia otáčania

15 mm

17 mm

19 mm

21 mm

22 mm

280,00

max. Uvoľňovací moment: 690 Nm
Pohon: 1/2"

515.6100

VRÁTANE



napätie akumulátora: 18,0 V
Max. nabíjaci prúd: 8 A

napätie akumulátora: 18,0 V
Akumulátorová technológia: Litium-iónový
Kapacita akumulátora: 4,0 Ah

dodávka vrátane dvoch 4,0 Ah
akumulátorov a 8 A rýchlonabíjačky



Napínací kľúč v
bočnej rukoväti

6 rýchlostných stupňov



Otáčky: 9000 ot./min
Vibračné zrýchlenie: < 4,831 m/s²
3,371 m/s²

311,00

515.6200

i



Ďalšie informácie



vrátane pevne zabudovanej
prepínateľnej 4-cestnej
zásuvkovej lišty pre ochrannú
vidlicu a 2 zásuvky USB-A

149,00



ponúka miesto na zavesenie
4 zariadení eMONSTER 18V

515.6901

eMONSTER nástenná skriňa na náradie

1.390 N·m

1/2"

90 mm

185 mm



515.1150

1

207,00

1.390 N·m

1/2"

95 mm

190 mm



515.1270

2

155,00

1.084 N·m

1/2"

115 mm

180 mm



515.1315

3

72,00

1.600 N·m

1/2"

170 mm

185 mm



515.1200

4

72,00

SILNÉ ARGUMENTY!

2.000 N·m

3/4"

170 mm

185 mm



515.3400

5

130,00

1.690 N·m

1/2" 3/4"

175 mm

200 mm



515.1210

6

155,00

7

197,00

3.405 N·m

3/4" 1"

40 mm

350 mm

230 mm



515.3250

9

883,00

11

883,00

3.405 N·m

3/4" 1"

195 mm

350 mm

230 mm









515.3260

10

940,00

12

940,00

													
		Nm	U/min	m/s ²	dBa	dBa	U/min	PT				Kg	
1	515.1150	1/2"	1390	10.000	<9,18	102,0	113,0	135	1/4"	-	✓	-	1,08
2	515.1270	1/2"	1390	10.000	<9,18	102,0	113,0	135	1/4"	-	✓	-	1,3
3	515.1315	1/2"	1084	9000	<10,36	106,0	115,0	169	1/4"	-	✓	-	1,2
4	515.1200	1/2"	1600	8500	<17,5	89,9	100,9	169	1/4"	✓	-	-	2,1
5	515.3400	3/4"	2000	8500	<17,25	91,0	100,9	196	1/4"	✓	-	-	2,2
6	515.1210	1/2"	1690	7930	<17,9	87,0	98,0	178	1/4"	✓	-	-	2,1
7	515.3785	3/4"	1690	7930	<13,56	88,0	104,0	178	1/4"	✓	-	-	2,2
8	512.0002	1/2"	2300	8500	<8,69	99,7	110,9	244	1/4"	✓	-	✓	1,6
9	515.3250	3/4"	3405	6200	<12,57	115,5	104,5	283	1/2"	✓	-	-	6,7
10	515.3260	3/4"	3405	6200	<12,88	115,5	104,5	283	1/2"	✓	-	-	7,7
11	515.3270	1"	3405	6200	<12,57	115,5	104,5	283	1/2"	✓	-	-	6,7
12	515.3280	1"	3405	6200	<12,88	115,5	104,5	283	1/2"	✓	-	-	7,8

 vysokovýkonný dvojitý mechanizmus úderov kladiva

 Vysokovýkonný úderový mechanizmus Jumbo

 technológia BITURBO



ROCKET II
2300
VB BITURBO



BITURBO

**S BI-TURBOM PLNÝCH 2 300 NM
LEN ZA CCA 15 SEKÚND!**

512.0002

8



145,00

VB 8 NAMIESTO 6 LISTOV ROTORA

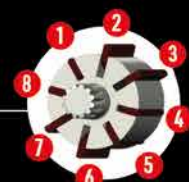

SOFISTIKOVANÝ ODVOD VZDUCHU



**max.
2.300
Nm**

**LEN!
1,6 KG**

1/4" PT	8.500 rpm	max. 2300 Nm	max. 851 Nm	max. 1256 Nm	244 L/min	6,3 bar	3,8" - 10,0 mm	1,6 kg	<8,69 m/s ²	110,9 dbA	99,7 dbA	max. M 16
---------	-----------	--------------	-------------	--------------	-----------	---------	----------------	--------	------------------------	-----------	----------	-----------

2. GENERÁCIA: EŠTE VÝKONNEJŠÍ, EŠTE SILNEJŠÍ, EŠTE LEPŠÍ!

Univerzálna bezpečnostná spojka 3v1 **NEW**

Ďalšie informácie

UNIVERZÁL - JEDEN ZA VŠETKÝCH

15,00

999.9101	A	9 mm	15,00 €
999.9102	A	11 mm	15,00 €
999.9103	A	14,5 mm	15,00 €
999.9104	B	1/4" AG	15,00 €
999.9105	C	1/4" IG	15,00 €

20,00

Ďalšie informácie

515.1921 Súprava pneumatických vyfukovacích pištolí

ROBUSTNÉ OCEĽOVÉ VYHOTOVENIE

NEW

i

Ďalšie informácie

Hybridná polymérová hadica

1

179,00

A → **Ø 10 MM X 20 M**

1 m 20 m

180°

Technické údaje:

max. Tlak:	12 bar
Dĺžka hadice:	20 + 1 m
Vnútorý priemer hadice:	10 mm
Pripájací závit:	3/8"
Pripustný teplotný rozsah:	-40 - 60 °C

515.3425 **Navijak hadice na stlačený vzduch**

3/8"

Automatický navijak hadice na stlačený vzduch

15 m 1,5 m

i

Ďalšie informácie

1

124,00

A → **Ø 10 MM X 15 M**

180°

Technické údaje:

max. Tlak:	20,0 bar
Dĺžka hadice:	15 + 1,5 m
Vnútorý priemer hadice:	10,0 mm
Pripájací závit:	1/4"

515.3440

B → **Ø 13 MM X 15 M**

i

Ďalšie informácie

1

187,00

515.3445

Technické údaje:

max. Tlak:	20,0 bar
Dĺžka hadice:	15 + 1,5 m
Vnútorý priemer hadice:	13,0 mm
Pripájací závit:	3/8"

i

Ďalšie informácie

3 5000 rpm, 57 dB, 4,9 m/s, 56,9 W

2 4500 rpm, 51,5 dB, 4,3 m/s, 53 W

1 4000 rpm, 48 dB, 3,5 m/s, 49 W

1

52,00

**EXTRÉMNE TICHÝ
ULTRALAHKÝ
< 3,5 KG**

Ø 440 mm 610 mm 570 mm

180°

999.2000 **Dielenský ventilátor, 70 wattov**

i

Ďalšie informácie

Paralelný zverák

**PRE VYSOKÉ NÁROKY
NA SKRUTKOVANIE!**

1

od 172,00

indukčne kalené
čeluste a
kovadlina

360°

od 172,00

914.0004	120 mm	4"	172,00 €
914.0005	140 mm	5"	186,00 €
914.0006	160 mm	6"	197,00 €
914.0008	200 mm	8"	239,00 €

s otočným tanierom

TOP
SELLER

1

Ďalšie informácie

480 mm
320 mm
36 mm
1.150 mm
36 mm
550 mm

A
B

od **12,00**

A	500.8040	480 mm	12,00 €
B	500.8045	1.150 mm	41,00 €

1

Ďalšie informácie

420 - 540 mm

62,00

500.8030

TU STE VŽDY NA SPRÁVНОM MIESTE!

2

Ďalšie informácie

85 mm
400 mm
490 mm
1.040 mm

72,00

500.8011

3

Ďalšie informácie

420 mm
145 mm
1.200 mm
510 mm
145 mm

104,00

500.8000

	1	2	3	4
Technické údaje:	500.8030	500.8011	500.8000	500.8090
Farba	červený	červený	červený	červený
Materiál	kov	kov	kov	plast
počet radiacích koliesok	5	6	6	6
pojazdný	✓	✓	✓	✓
druh pneumatik	plast	plast	plast	plast
čalúnený	✓	✓	✓	✗
výškovo nastaviteľný	✓	✓	✓	✗
Obsah obalu	1	1	1	1
celková dĺžka L v mm	370,0 mm	1040,0 mm	1200,0 mm	1030,0 mm
šírka B	370,0 mm	490,0 mm	420,0 mm	480,0 mm
výška H	420,0 - 540,0 mm	85,0 - 400,0 mm	145,0 - 510,0 mm	115,0 mm
Celková nosnosť kg	90 kg	90 kg	90 kg	120 kg

4

Ďalšie informácie

70,00

480 mm
115 mm
1.030 mm

500.8090

i **3**
 Ďalšie informácie

Geniálne flexibilné

46,00

500.8077 Súprava úložného priestoru na náradie zo silikónu

53 x 29,5 x 3,2 cm

25,5 x 23,3 x 2,4 cm 27,5 x 14,5 x 2,4 cm

ZORGANIZUJTE SI VECI

i **38**
 Ďalšie informácie

12 pohyblivých držiakov pre 1/4", 3/8" a 1/2" nástrčkové orechy

12 x 1/4"
 12 x 1/2"
 12 x 3/8"

30 x 15,5 cm

15,00

800.0185 Magnetický organizačný systém pre nástrčné orechy

NEW

i **1**
 Ďalšie informácie

Magnetická podložka

320 mm
 100 mm
 245 mm

od 10,00

800.0180 100 mm 10,00 €
 800.0175 245 mm 20,00 €

NEW

i **1**
 Ďalšie informácie

NEW

10-18 kg

Ø 72 mm

10 - 18 kg

10,00

800.0165 Magnetický držiak



PRE NOVÁČIKOV!

od **35,00**

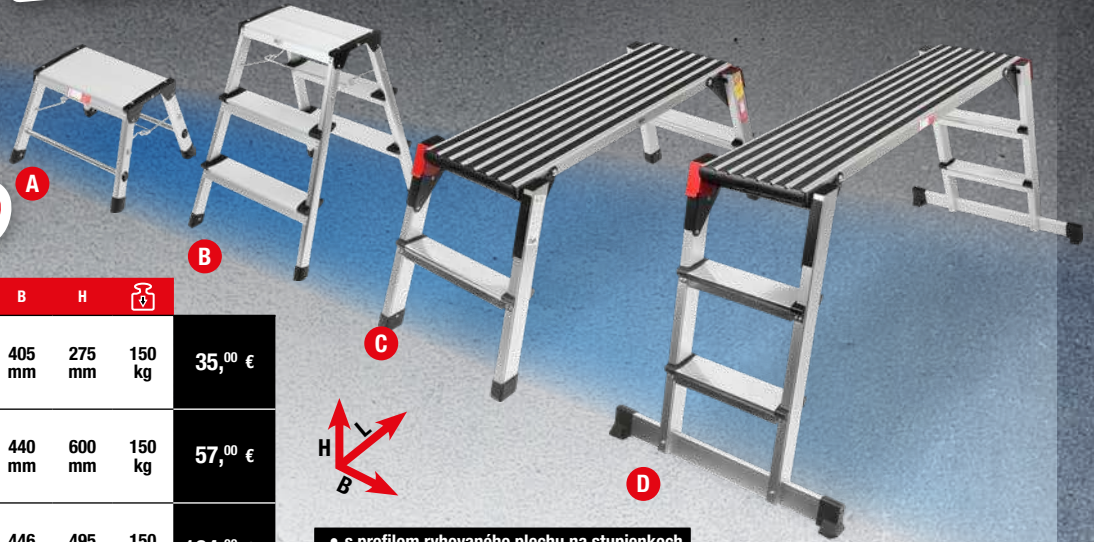

			L	B	H	📦		
A	800.0975			380 mm	405 mm	275 mm	150 kg	35,00 €
B	800.0965			620 mm	440 mm	600 mm	150 kg	57,00 €
C	800.0960			1270 mm	446 mm	495 mm	150 kg	104,00 €
D	800.0985			1650 mm	380 mm	730 mm	150 kg	139,00 €

- s profilom ryhovaného plechu na stupienkoch
- žiadne preklopenie vďaka šikmo umiestneným stojanovým nohám
- vystupovanie z oboch strán
- sklápatelné a v dôsledku toho skladovateľné s úsporou miesta
- plastové hrany na nohách chránia plošinu a podlahu

Ďalšie informácie

54,00

140.2226

Ďalšie informácie

187,00

500.8100

Ďalšie informácie

XXL

1246,00

865.0201 XXL dielenský pracovný stôl s 3 zásuvkami a 1 dverami

1
 Ďalšie informácie

**NEUVERITEĽNE MALÝ,
 NEUVERITEĽNE JASNÝ!**

max. 3-7 h
 2,5 h
 IP45

MAX. 500 LUMENOV

114 mm

70 Lumenov

19,00

UltimateBEAM Hliníkové LED inšpekčné svetidlo Li-Ion 500 lúmenov

150.4530

NEW

USB C
 U
 AL

1
 Ďalšie informácie

**KOMPAKTNÝ
 A ROBUSTNÝ**

max. 2-4,5 h
 1,5 h
 IP20

160 mm

150 Lumenov

20,00

UltimateBEAM hliníkové LED ceruzkové svetidlo Li-Ion, 150 lúmenov

150.4540

NEW

1
 Ďalšie informácie

max. 3 h
 3 h
 IP20

MAX. 350 Lumenov

UV LED
 s laserovým ukazovateľom

165 mm

17,00

nabíjanie pomocou USB-C kábla (súčasť balenia)

LED COB Stripe inšpekčná lampa 350 lumenov s UV bodovou LED diódou a laserovým ukazovateľom

150.4400

1
 Ďalšie informácie

25 m
 max. 10 h
 IPX3

85 Lumenov

15,00

140 mm

25 m

perfectLight vreckové svetidlo 85 lumenov

150.4370

Modi	COB 100%	COB 40%	COB rot	XPE 100%	XPE 40%
LED	270° 3 Watt COB LED			1 Watt High Power XPE LED	
40% 100%	350 LM	150 LM	-	100 LM	40 LM
⌚	3 h	6 h	8 h	4 h	8 h

1
 Ďalšie informácie

MAX. 100 Lumenov
MAX. 350 Lumenov

270°

Senzorový spínač On/Off

USB-C

Power Display

Nastavenie veľkosti

XPE LED 2 úrovne osvetlenia

COB LED 3 úrovne osvetlenia

15,00

40 - 350 Lumen
 4,5 h
 max. 8 h
 IPX4
 95 g

TOP SELLER

150.4520

Pohybový senzor

1
 Ďalšie informácie

18,00

TOP SELLER

250 Lumenov

500 Lumenov

USB

ON OFF

1200 mAh lítium-iónová batéria (súčasť balenia)

180°

alebo

3x AAA batérie (nie sú súčasťou balenia)

vrátane funkcie USB power banky

20 %	●
40 %	●●
60 %	●●●
80 %	●●●●
100 %	●●●●●

150.4510

max. 3 h

3 h

IP65

1
 Ďalšie informácie

20,00

130 Lumenov

300 Lumenov

USB-A OUT

USB-C IN

ON OFF

USB-A OUT

Funkcia power banky

integrovaná lítium-iónová batéria 1.200 mAh

20 %	●
40 %	●●
60 %	●●●
80 %	●●●●
100 %	●●●●●

150.4505

max. 3 h

3 h

IP65

1
 Ďalšie informácie

17,00

60 Lumenov

150 Lumenov

max. 3,5 h

2,5 h

IP20

360°

Micro USB

ON OFF

20 %	●
40 %	●●
60 %	●●●
80 %	●●●●
100 %	●●●●●

150.4495

180°

1
 Ďalšie informácie

39,00

250 Lumenov

550 Lumenov

max. 3,5 h

3 h

IP65

USB-A OUT

USB-C IN

360°

360°

20 %	●
40 %	●●
60 %	●●●
80 %	●●●●
100 %	●●●●●

150.4490



Koniec spletených káblov!

Bezdrôtové nabíjanie je teraz ešte rýchlejšie!



ULTIMATE BEAM BY KSTOOLS



MAX. 100 Lumen

Ø 16,6 mm

573 mm

MAX. 100-1000 Lumen

max. 3,7-9 h

max. 10,6 h

573x Ø30 mm

138x Ø35 mm

3 IN 1

Pre zdvížné plošiny alebo dielenské skrine

Na nástennú montáž

169,5 mm

100 mm

1x 20W ✓

2x +

1x 40W ✓

4x + + + +

* Súčasťou dodávky nie je napájací zdroj ani nabíjací kábel.

IP20 IK07

169,5x 100x14,15 mm

max. 20W

150.4611 Nabijacia podložka s dvoma nabíjacími bodmi **30,00**

MAX. 170 Lumen

MAX. 110-1100 Lumen

MAX. 90-850 Lumen

MAX. 100-1000 Lumen

249 mm

138 mm

max. 3,4-9 h

max. 2,6-8 h

max. 7,6 h

180°

90°

249 mm

156,5x 51x36,5 mm

IP54 IK07

150.4600 3v1 súprava pracovných svetiel Quick-Lock, 4-dielna **80,00** 4 KS

MAX. 170 Lumen

MAX. 110-1100 Lumen

MAX. 100/200 Lumen

MAX. 100 Lumen

MAX. 100/200 Lumen

MAX. 100 Lumen

Clip

max. 2,5-6,5 h

max. 7,25 h

IP54 IK07

257x 55x37 mm

90°

257 mm

165 mm

165 mm

165 mm

max. 5,3/8 h

max. 4 h

IP54 IK06

165x 22x15,7 mm

165x 22x15,7 mm

165x 22x15,7 mm

365 nm UV LED

150.4610 Ručná lampa **49,00**

150.4640 Inšpekčné svetlo **25,00**

150.4641 UV svetidlo na hľadanie netesností 365 nm **25,00**



Technológia



100%



MAX. 100 Lumen
MAX. 350/450 Lumen
 69 mm
2 IN 1

150.4625 UltimateBEAM eQi 2v1
 čelovka/pracovné svetlo **35,00**

MAX. 20-180 Lumen
MAX. 20-180 Lumen
 251 mm
 odnímateľné

150.4630 2v1 krčná lampa s dvoma
 odnímateľnými pracovnými
 svetlami **42,50**

MAX. 140 Lumen
MAX. 50-600 Lumen
 133 mm
 90°

150.4615 Ručná lampa kompaktná **42,50**

MAX. 90 Lumen
MAX. 150/350 Lumen
 180 mm

150.4620 Ručná lampa tenká **27,50**

MAX. 130-1300 Lumen
 96 mm
 90°

150.4635 mini pracovné svetlo **42,50**

Číslo výrobku	Prepínateľná intenzita svetla	plynulo stmievateľné	Hlavné svetlo max. lúmen	Bodové svetlo max. lúmen	Farba svetla (Kelvin)	max. doba svietenia hlavného svetla (h)	max. doba svietenia bodového svetla (h)	Hmotnosť batérie (g)	Ochrana proti striekajúcej vode	Trieda odolnosti proti nárazom	Rozmery (DxŠxV) v mm	Hmotnosť netto (g)	max. doba nabíjania s káblom (h)	max. doba nabíjania s nabíjacou podložkou (h)
150.4610	✓	✓	110-1100	170	6000	2,5-6,5	7,25	50,71	IP54	IK07	257x55x37	320	3,25	6,8
150.4615	✓	✓	50-600	140	6000	3,75-12	9,5	39	IP54	IK07	133x62,6x26	185	3	4,7
150.4620	✓	✗	150/350	90	6000	3,8/2	7,6	18,8	IP54	IK07	180x31x17,4	75	2	2,25
150.4625	✓	✗	350/450	100	6000	2,4/3,5	6	22	IP54	IK07	69x32x44	85 g svetlo; 40 g hlavový pás	1,7	2,8
150.4630	✓	✓	2x 20-180	/	6000	/	2	12	IP54	IK07	251x137x49	225	1,7	2,5
150.4635	✓	✓	130-1300	/	6000	3,6-7,2	/	73,45	IP54	IK07	96x65x40,5	300	4,2	9,35
150.4640	✓	✗	100/200	100	6000	4/2,3	2,8	10,69	IP54	IK06	165x22x15,7	56,5	1,85	2,8
150.4641	✓	✗	/	/	365nm	5,3/8	4	10,69	IP54	IK06	165x22x15,7	56,5	1,85	2,8
150.4600	✓	✓	/	/	/	/	/	50,71	IP54	IK07	/	585	3,6	4,9
150.4601	✓	/	/	/	/	/	/	50,71	IP54	IK07	156,5x51x36,5	220	/	/
150.4602	✓	✓	110-1100	170	6000	2,6-8	7,6	/	IP54	IK07	249x035	90	3,6	4,9
150.4603	✓	✓	100-1000	100	6000	3,7-9	10,6	/	IP54	IK07	573x030	120	3,6	4,9
150.4604	✓	✓	90-850	/	6000	3,4-9	/	/	IP54	IK07	138x035	155	3,6	4,9
150.4611	/	/	/	/	/	/	/	/	IP20	IK07	169,5x100x14,15	220	/	/

i **1**

Ďalšie informácie

max. 8 bar (116 PSI)	60° C 140° F

20,00

150.8271

Tlakový čerpací rozprašovač peny (penič)

i **1**

Ďalšie informácie

88,00

500.8013

Pojazdný stolček

i **1**

Ďalšie informácie

6,3 bar	96 L/min
92 dbA	1/4" PT

41,00

515.5090

Pneumatická nasávací a fúkačiaci pištoľ

i  **1**
 Ďalšie informácie

Ø 88 mm

5/16" x 24F

15 mm

7,50

NEW



515.5481 Vymazávač fólie

i  **1**
 Ďalšie informácie

NA MATNÉ LAKY

Ø 88 mm

5/16" x 24F

15 mm

10,00

NEW



515.5491 Gumovací tanier na matné laky



i  **10**
 Ďalšie informácie

60,00

CENA SÚPRAVY = 10X

515.5486



i  **10**
 Ďalšie informácie

80,00

CENA SÚPRAVY = 10X

515.5496



i  **1**
 Ďalšie informácie





300 mm

245 mm

regulovateľný

147,00

515.1980 Pneumatická vyfukovacia pištoľ

		
1/4" NPT	8000	160 L/min
		
6,3 bar (90psi)	3/8" - 10 mm	<3,90 m/s²
		
106 dbA	95 dbA	1000 ml

i  **1**
 Ďalšie informácie



NEW



DOBRE VYZBROJENÝ!

150 mm

Ø 43 mm

105 mm

40,00

515.5595 Pneumatická čistiaca pištoľ

		
1/4" PT	80 L/min	12 bar 90 psi
		
3/8" - 10 mm	102 dbA	91 dbA

i  **23**
 Další informace

UDRŽUJTE PRESNÚ VZDIALENOSŤ

NEW

Ø 10,2 mm

M8 x 50 mm

1x 17/19 mm 1x 18/20 mm 1x 18,2/22,5 mm

1x 26,7/24 mm 1x 26/32 mm 1x 29,3/27 mm 1x 38,9/28,1 mm

49,00



140.2650 Súprava dierovadiel pre dištančné snímače (PDC)

i  **6**
 Další informace

31,00

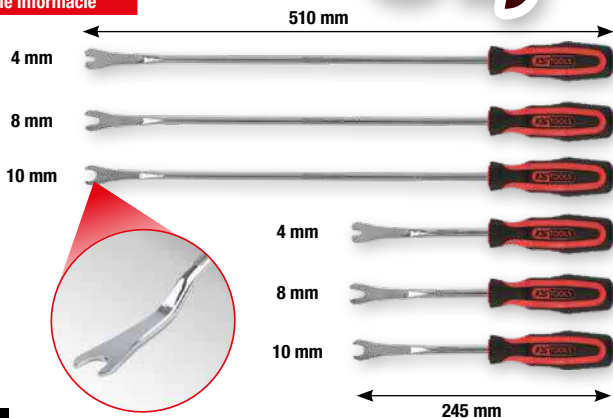

140.2370 Súprava na uvoľňovanie svoriek



i  **11**
 Další informace

20,00

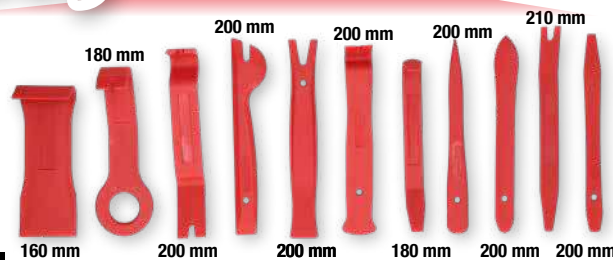

911.8205 Súprava plastových klinov



i  **303**
 Další informace

NEW

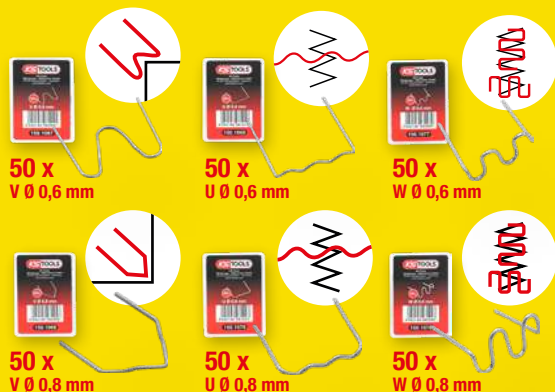

i
 jedno nabitie akumulátora vystačí na cca 400 opravných svoriek

150.1065 Súprava na opravu plastov (bezkáblová)

45°

MAX. 600°C

98,00

DC 5V 2A 600°C max

3,7 V 30 W 4.000 mAh 3 h ≈400x

i **1**
 Další informace **VOLVO** **NEW**

38,00

140.2152 Nástroj na nastavenie radarového snímača pre Volvo

i **1**
 Další informace **VOLVO** **NEW**

50,00

140.2153 Nástroj na nastavenie kamery parkovacieho asistenta pre Volvo

i **1**
 Další informace **TESLA** **NEW**

na demontáž vrchného krytu zadného svetla

9,00

10 **3/8"**

150.8101 Špeciálne náradie na demontáž zadného svetla pre Tesla Model 3

i **1**
 Další informace **NEW**

630 mm
250 mm
Ø 3 - 43 mm

80,00

115.0908 Univerzálne kliešte na hadicové spoje s lanovodom

i **1**
 Další informace **NEW**

180 mm
25 mm
Ø 0 - 30 mm

32,00

115.0907 Kliešte na hadicové spoje pre samosvorné spony

i **7**
 Další informace

MIMORIADNA ŽIVOTNOSŤ!

83,00

Ø 0 - 38 mm **1**
 Ø 0 - 48,5 mm **4**
 Ø 0 - 30 mm **2**
 Ø 0 - 45 mm **5**
 Ø 0 - 65 mm **3**
 Ø 0 - 45 mm **6**
 Ø 0 - 60 mm **7**

115.1055 Súprava klieští na hadicové spoje na motor. vozidlá



Ďalšie informácie

INÍ HĽADAJÚ. VY NÁJDETE!

NEW

Technické údaje:

Napájanie prúdom:	12 V DC (batéria vozidla) alebo akumulátor KS Tools eMONSTER
Dymový výkon:	20 - 30 ml/min
Doba použitia:	10 - 25 min (s 10 - 20 ml oleja)
Doba chladenia:	10 - 20 min

1 eMONSTER vrát. 2,0 Ah akumulátora

2 alebo s batériovými svorkami



349,00

eMONSTER

OPTIONAL

Dymový olej

250 ml

10,00

550.1483

Dymový stroj na detekciu netesností, s 2 Ah batériou

550.1470



Ďalšie informácie

NEW

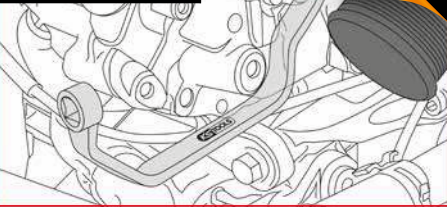

13 mm

166 mm

12,00

3/8"



Špeciálny nástrčkový kľúč pre skrutkové spoje sacích potrubí, VAG

150.2518



Ďalšie informácie

10,50



Ø 15 mm

Ø 30 mm

Ø 60 mm

150 mm

180 mm

250 mm

115.5050



Ďalšie informácie



Ø 35 mm

Ø 15 mm

Ø 23 mm

155 mm

255 mm

165 mm

115.5055



13,00

i  
Ďalšie informácie



15,00

Ručná pumpa na odsávanie a plnenie, 0,2 litra

150.9221 

i  
Ďalšie informácie

15,00 **NEW**



27 mm



12

Ø 60 mm

 **AUDI E-TRON**

Špeciálny nástrčný kľúč na demontáž nádrže chladiacej kvapaliny pre Audi

150.1924

i  
Ďalšie informácie



1/2"

108 mm

13,00

Nástroj na uvoľnenie krytu chladiča pre VAG

150.1919

i  
Ďalšie informácie



12,0 V

20,00

Elektrické čerpadlo na odsávanie a plnenie oleja

150.2820

i  
Ďalšie informácie

Spojka
7,2 mm na 4,4 mm



7,2 mm

80 mm

4,4 mm

20,00

150.1936

i  
Ďalšie informácie

Spojka
4,4 mm na 7,2 mm



4,4 mm

74 mm

7,2 mm

26,00

150.1937

NA ROZŠÍRENIE

i  
Ďalšie informácie

max. 76 cm

0 - 200 °C
0 - 400 °F

1600 mm



R123 R124

R123 R125

#1

#2

#3

M50 x 2,5

M42 x 3

M58 x 3

M62 x 3

M48 x 4

M45 x 3

M50 x 2,5

M60 x 4

M52 x 3

M48 x 2,5

M42 x 2,5

M50 x 3

M46 x 3

M34 x 2,5

75 mm

187,00

150.1930

Servisná súprava na diagnostiku chladiaceho systému

 0 - 2,5 bar  

i  **8**
Ďalšie informácie

250 ml

KSTOOLS

REAKTIONSLÖSLIGHEIT
 REACTION FLUID
 LIQUIDE REACTIF
 LIQUIDO DE REACCIÓN
 LIQUIDO REAGENTE
 REAKTIVSÄMME
 SOUVREIN
 REACTIVLÖSLIGTOPP
 VITRO ANTISPÄRRE
 PEAKENT

150.1914

VOLITELNÉ

15,00

150.1914

104,00

150.1910 Súprava na testovanie netesnosti hlavy valcov pomocou CO2



i  **4**
Ďalšie informácie

NEW

KAŽDÁ ISKRA SA POČÍTA!

97 mm **3/8"**

39,00

14 mm 16 mm 18 mm 21 mm

Súprava nástrčných orechov na zapalovacie sviečky, magnetická s kĺbom

517.1145 **3/8"** 14 - 16 - 18 - 21 mm



i  **2**
Ďalšie informácie

FORD ECOBOOST

14 mm 180 mm

PRE MOTORY FORD ECOBOOST 1,0 L

16 mm 215 mm

26,00

PRE MOTORY FORD ECOBOOST 1,5 L

Súprava nástrčných orechov pre zapalovacie sviečky pre motory EcoBoost

517.1135 **3/8"**





Ďalšie informácie

- na dodatočné vyrezávanie zhrdzavených a poškodených závitov sond
- ideálne pre snímače NOX a snímače filtrov pevných častíc na výfukových sústavách
- so 6 reznými hranami pre ideálne centrovanie
- mimoriadne krátke vyhotovenie
- s čistiacimi drážkami vo vodiacom čape

187,00

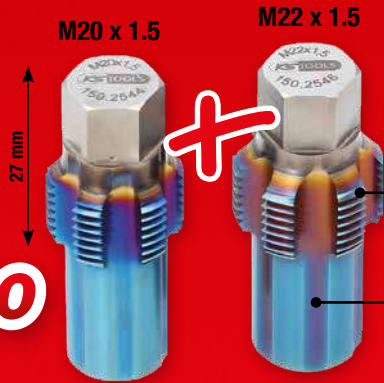

so 6 reznými hranami pre ideálne centrovanie

s čistiacimi drážkami vo vodiacom čape



TOP SELLER

150.2540 Súprava závitrezov s vodiacim čapom pre snímače

VŽDY DOBRÉ VÝSLEDKY!



Ďalšie informácie

Závitrez s vodiacim čapom

- na dodatočné vyrezávanie zhrdzavených a poškodených závitov sond



L1 L2



so 6 reznými hranami pre ideálne centrovanie

s čistiacimi drážkami vo vodiacom čape

104,00

A	150.2541	pre teplotné senzory	M12 x 1,25	55 mm	33 mm	13 mm	104,00 €
B	150.2542	pre teplotné senzory	M14 x 1,5	45 mm	30 mm	13 mm	104,00 €
C	150.2543	pre lambda sondy	M18 x 1,5	42 mm	27 mm	13 mm	104,00 €
D	150.2544	pre senzory NOX	M20 x 1,5	50 mm	27 mm	13 mm	104,00 €
E	150.2546	pre senzory filtrov pevných častíc	M22 x 1,5	50 mm	27 mm	13 mm	104,00 €

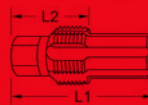

TOP SELLER



Ďalšie informácie



176,00

Súprava tlakových a podtlakových púmp

150.1900



Ďalšie informácie



52,00

súprava montážneho náradia pre univerzálny tesniaci krúžok na hriadeľi a Simmeringový krúžok

700.1280

i  **2**
 Ďalšie informácie

T50

15,00

24 mm
17 mm
1/2" 24 mm

Oblasť použitia: Ford s dieselovými motormi 2.0L EcoBlue, 2.0L Duratorq TDCi (DW10F)

150.3270 Súprava náradia na remenice pre drážkové remene, Ford

NEW

i  **1**
 Ďalšie informácie

• na upínanie a uvoľňovanie napínacej kladky ozubeného remeňa
 • nastaviteľný, univerzálne použiteľný
 • vnútorný štvorhran podľa DIN 3120 / ISO 1174
 • s pohonom s vonkajším šesťhranom 13,0 mm
 • fosfátovaný

1/4" 13 mm
0,3,0 mm
8 - 25 mm

20,00

Univerzálny čapový kľúč pre napínanie kladky ozubeného remeňa, nastaviteľný

150.3046

i  **1**
 Ďalšie informácie

10,50

Oblasť použitia: Citroën, Peugeot, Opel a Toyotas benzínovými motormi 1,0 a 1,2 (kód motora: ZMZ (EBOF / EBO) / HM01 (1PP) / HMV, HMZ (EB2) / HMZ (EB2) / HMT (EB2D) / HMU (EB2D) / HNZ (EB2DT) / HNY (EB2DTS) / HMY (EB2M) / HMY (EB2M) / B12XE (EB2F) / D12XE (EB2FA) / B12XHL (EB2DT) / D12XHL, F12XHL (EB2ADT) / B12XHT (EB2DTS) / D12XHT, F12XHT (EB2ADTS)

120 mm

400.2118 Skúšobné náradie na ozubený remeň pre PSA

i  **7**
 Ďalšie informácie

2 V 1

225,00

90 mm
220 mm M14 x 1,5
27 mm 15 mm
Ø 50 mm Ø 47 mm

Oblasť použitia: Audi A1 (8X), A3 (P), Seat Altea (5P), Leon (1P), Ibiza IV (6J, 6P), Toledo IV (KG), Škoda Fabia II (542,545), Octavia II (1Z), Rapid (NH1, NH3), Roomster (5J), Yeti (5L), Volkswagen Golf VI (5K, AJ,517), Golf Plus (5M,521), Polo V (6R, 6C), Jetta VI (162, 163, AV), Caddy III (2K, 2C), Beetle (5C), Touran (1T)
 Kódy motora: 2.0L TSI / TFSI (CBZA, CBZB, CBZC)

VW 1,2 TSI

400.0910 Súprava náradia na montáž ozubených kolies pre VAG

NEW

NEW



Ďalšie informácie

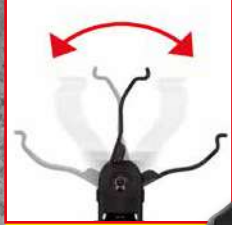

39,⁰⁰



Náradie na uvoľňovanie rýchlospojky s otočnou hlavou

115.0909



Ďalšie informácie

RÝCHLO A BEZPEČNE!



25,⁰⁰



Kliešte na palivové vedenie pre rýchlospojky s kĺbom

115.0906

NEW



Ďalšie informácie



29,⁰⁰

Náradie na uvoľňovanie palivového potrubia pre BMW a Mini

115.1102



Ďalšie informácie



- na montáž a demontáž ťažko otvárateľných spojov vedení s pružinovým uzáverom CLIC pri palivových vedeniach, vedeniach klimatizácií, vzduchových a hydraulických vedeniach.
- žiadne poškodenie násuvných spojov, palivových vedení a palivových hadíc
- rýchle a jednoduché rezanie palivových vedení
- pre takmer všetky spojky vedení na európskych, ázijských a amerických vozidlách



52,⁰⁰

Súprava na odblokovanie konektora linky

115.1260





Ďalšie informácie

JEDNODUCHÉ STAHOVANIE 3 873 ÚDEROV ZA MINÚTU!

TOP
SELLER

- vrátane 7 adaptérov pre takmer všetky vstrekače
- mimoriadne vysoký rázový účinok (3365 (6,3 bar) / 3873 (8 bar) úderov za minútu)
- na demontáž zapečených injektorov v hlave valca
- odsávač sa pomocou vhodného adaptéra priskrutkuje k tesne usadenému vstrekovaciemu hrdlu
- malá potreba miesta vďaka kompaktnej konštrukcii



A

B

C



D

E

F

G

H



3.873 x 1 min

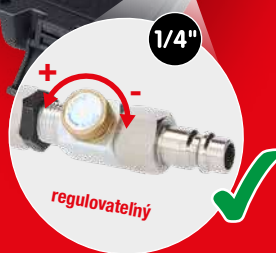

1/4"

regulovateľný

223 L/min	3/4"-19 mm	108,4 dbA
6,3 bar (90 psi)	71,9 m/s ²	6 mm
max. 12 bar	119,4 dbA	M18 x 1,5



A	M25 x 1,0	Siemens
B	M20 x 1,0	Denso
C	M27 x 1,0	Siemens
D	M27/M17/10 mm	Bosch/Fiat/BMW/PSA/Mercedes/Renault
E	M18 x 1,5	Adaptér
F	M17 x 1,0	Bosch/Mercedes
G	M16 x 1,0	Toyota
H	M14 x 1,5	Bosch/Delphi/BMW

280,00



BOSCH
DENSO
DELPHI
SIEMENS



...

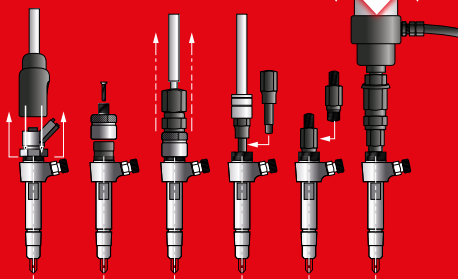

152.1130

Súprava na vyťahovanie vstrekačov
stlačeného vzduchu

6
 Ďalšie informácie

285 - 875 mm
 150 - 675 mm
TELESKOPICKY VYSŪVATEĽNÉ

500g
 200g
 1000g
 2000g
 3000g

Ø 4 mm
 Ø 13 mm
 Ø 16 mm
 Ø 19 mm

400 mm
 510 mm

28,00

550.1090 Flexibilný a teleskopický magnetický držiak a súprava inšpekčných zrkadiel

1
 Ďalšie informácie

50 mm
 180 mm
 30/23 mm
 4 mm

25,00

115.1108 Oddelovacie kliešte na elektrické prípojky

1
 Ďalšie informácie

125 mm
 6 - 24 V
5,00

550.1504 Skúšobná lampa 6 - 24 V

2
 Ďalšie informácie

62,00

1 Prijímač
 2 Vysielač s krokodílikovými svorkami

150.3075 Detektor skratu

1
 Ďalšie informácie

140 mm
12,00
 3 - 48 V

550.1503 Skúšačka polarity a napätia 3 - 48 V

i   **1**
Ďalšie informácie

Oblasť použitia: Audi e-tron GT (< 2021), Porsche Taycan (< 2021)

51 mm

7,50

150.1366 Odblokovacie náradie pre komunikačné konektory na batériovom module HV batérie pre Audi a Porsche

NEW

i   **1**
Ďalšie informácie

16 mm

63 mm

1/2"

7,50

150.1301 Nástrčný bit inbusový pre upevňovacie prvky vysokonapäťovej batérie pre VAG

NEW

i   **1**
Ďalšie informácie

148,00

pre dutinkové káblkové oká od 10 do 120 mm²

570 mm

115.1410 Krimpovacie kliešte na svorky batérie

NEW

i   **25**
Ďalšie informácie

Silikon max. 24V (10A) Ø 4 mm

Ø 4 mm 1100 mm

Ø 4 mm 140 mm

Ø 4 mm 80 mm

Ø 4 mm 160 mm

Ø 4 mm 47 mm

Ø 4,0 mm → 2,0 mm 175 mm

Ø 4,0 mm → 2,0 mm 175 mm

Ø 4 mm 85 mm

Ø 4 mm 105 mm

Ø 4 mm 155 mm

MERATELNE LEPŠIE!

45,00

150.0895 12/24V súprava diagnostických kontrolných a meracích káblov

NEW

i   **1**
Ďalšie informácie

382,00

Takmer pre všetky batérie

S tlačiarňou a 3 kotúčmi papiera

550.1649 12 V / 24 V Digitálny prístroj na testovanie batérií a systému nabíjania s integrovanou tlačiarňou

MF WET AGM VRLA GEL ✓

START A STOP

Technické údaje:

Zobrazenie:	digitálny
Pracovná oblasť CA / MCA:	40-2.000 CCA
Pracovná oblasť CCA:	40-2.000 CCA
Pracovná oblasť DIN:	40-2.000 CCA
Pracovná oblasť EN:	40-2.000 CCA
Pracovná oblasť IEC:	40-2.000 CCA
Pracovná oblasť JIS#:	40-2.000 CCA
Pracovná oblasť SAE:	40-2.000 CCA
Pracovná teplota:	0 °C až +55 °C
Frekvenčné pásmo:	100 Hz
Merací rozsah:	9-36 V
Presnosť merania:	+/- 0,5 Megaohm
Rozsah napätia:	9-36 V



i **1**
 Další informace

623,00



12 V + 24 V Booster - mobilný prístroj
 na pomoc pri štartovaní 1400 A

550.1720

-
-
-
-
- 12/24 V
- 1400 A
- PEAK AMP
4400 A
-
-
- 1,6 m
35 mm²
-
- 2x22 Ah



1.400 A

SAFETY Xtreme



Inteligentný bezpečnostný koncept
 zabráňuje chybám používateľa:

Bezpečnostný obvod privádza prúd na svorky iba
 vtedy, keď:

- bol správne pripojený (pólovanie)
- spojenie je odolné proti skratu
- je prítomné správne napätie
- je batéria vozidla v poriadku

i **1**
 Další informace

**ABSOLÚTNE
 DÔVTIPNÝ!**

NEW



-
- 192 x 92
x 61 mm
-
- 430 g
-
- 9 V
-
-
- Data Hold



- V~ ▶ 6 V - 750 V
- A~ ▶ 60 mA - 20 A
- V... ▶ 600 mV - 1000 V
- A... ▶ 60 mA - 20 A
- Ω ▶ 600 Ω - 60 MΩ
- F ▶ 600 mA/1000V
(32x6 mm)
- ▶ 20 A/1000 V
(38x10 mm)

115,00

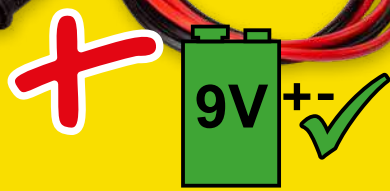

i **1**
 Další informace



< 44.500 V



s nástenným
 držiakom



1.680 mm

187,00

MÔŽE ZACHRÁNIŤ ŽIVOTY!

Isolovaná záchranná tyč

117.0215

Digitálny multimeter vrát. meracích hrotov s integrovanou ochranou proti nárazu

150.0913



Ďalšie informácie



3/8"

Súprava izolovaného náradia pre hybridy a elektromobily

117.1895

343,00

2 x		4 mm - 5,5 mm
2 x		PH1 - PH2
6 x		6 - 8 - 10 - 12 - 13 - 17 mm
1 x		185 mm
1 x		165 mm
1 x		3/8"
1 x		3/8": 200 mm
1 x		3/8": 125 mm
10 x		3/8": 8 - 10 - 11 - 12 - 13 - 14 - 16 - 17 - 19 - 22 mm
1 x		200 mm



Ďalšie informácie



1000 V

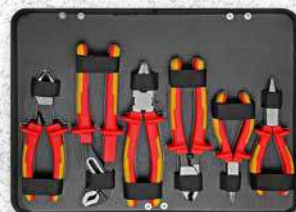

3/8"

587,00

Súprava izolovaného náradia pre hybridy a elektromobily

117.1890

4 x		2,5 - 3 - 3,5 - 4 mm
3 x		PH1 - PH2 - PH3
3 x		T20 - T25 - T30
1 x		210 mm
1 x		185 mm
1 x		165 mm
1 x		215 mm
1 x		165 mm
1 x		240 mm
2 x		10 - 25 mm
1 x		180 mm
1 x		3/8"
15 x		3/8": 6 - 7 - 8 - 9 - 10 - 11 - 12 - 13 - 14 - 16 - 17 - 18 - 19 - 20 - 22 mm
2 x		3/8": 150 - 250 mm
3 x		3/8": M8 - M10 - M12
1 x		Ø 200 mm
1 x		200 mm
1 x		500 m



Ďalšie informácie



so 4 pozdĺžnymi drážkami, 3 držiakmi na opasok a integrovanou kazetou na opasok s viskózovou brzdou



99,00

117.1555

Stípič bezpečnostného pásu



max. 2,50 m

1018 mm

hliník



10 KG
Ø 350 mm

10 KG
Ø 350 mm



7,50

Nástenný držiak na bezpečnostný pás

117.1556



Ďalšie informácie

VÁŠ VSTUP DO ELEKTROMOBILITY



Štvorcové dierovanie pre diely príslušenstva



uzamykateľný cez zabudovanú vložku zámku



pracovná doska s penovou vložkou s hrúbkou 10 mm



so samočinným vŕňovaním a funkciou SOFT-CLOSE



2 x s pohyblivou a otočnou brzdou, kolesá : Ø 125 mm

ecoLine

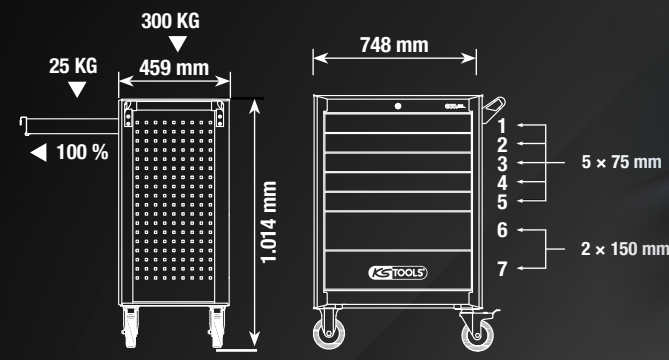
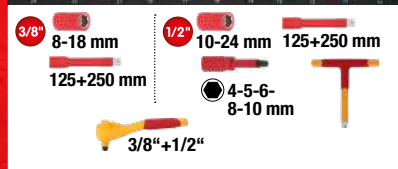
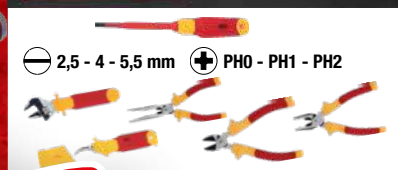

1349,00

VRTÁNE 42 DIELMI NÁRADIA

117.6144 ECOline dielenský vozík so 42 kusmi izolovaného náradia pre hybridné vozidlá a elektromobily

4466,00



Výstražný štítok hybridný blesk



200 mm

917.3898

Výstražný štítok hybridný spínač



Ø 200 mm

917.3897

Izolačná rohožka, 1000 mm, hrúbka 3,0 mm



117.3819

Podrukavica, 260mm



117.1660

Ochranná rukavica pre elektrikára s ochrannou izoláciou, veľkosť 10, pevnosť 1, biela



117.1664

Ochranný štít na tvár pre elektrikárov, trieda 2



117.1796



117.6172 3/8"+1/2" súprava izolovaných nástrčkových kľúčov s momentovým kľúčom v penovej vložke, 72-dielna



117.6133 Súprava izolovaných kľúčov v penovej vložke, 33-dielna

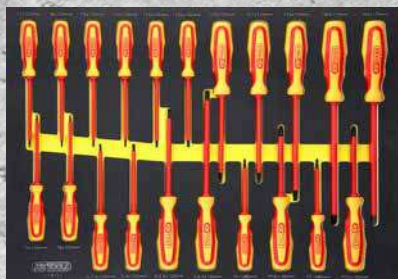

117.6121 ERGOTORQUE VDE súprava skrutkovačov v penovej vložke, 21-dielna



117.6117 ERGOTORQUE VDE súprava klieští v penovej vložke, 17-dielna

117.6155

PERFORMANCEplus dielenský vozík e10 so 164 kusmi izolovaného náradia pre hybridné vozidlá a elektromobily

10,50



117.0223

Stojan v tvare strechy so symbolom blesku a magnetom

NAJROZSIAHLEJŠÍ VO SVOJEJ TRIEDE



10,50

117.0222

Stojan v tvare strechy so symbolom blesku a prísavkou



15,00

117.0226

Stojan so symbolom blesku



188-stranový katalóg elektromobility nájdete na stránke www.kstools.com

145,00

117.1545

2 x Nožnicová bariéra z plastu

2x

72,00

117.1550

Súprava uzatváracích stĺpikov s retazou

4x

i  **4**
Ďalšie informácie

Ø 22,0 - 28,0 mm

Ø 15,0 - 21,0 mm

Ø 17,0 - 25,0 mm

Súprava nástrojov na centrovanie spojky

150.2180 Ø 15,0 - 28,0 mm

9,00



i  **11**
Ďalšie informácie

150 kg

310 mm

450 mm

300 mm

160.0910

Súprava univerzálnych držiakov pre prevodovku

410,00



i  **1**
Ďalšie informácie

NEW

34 mm

1/4"

150.9699

AUDI, PORSCHE, VW

10,00

Špeciálny nástrčný orech pre udržiavací ventil zvyškového tlaku na vzduchových odpruženiach

















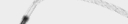

160.0910

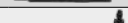
Súprava univerzálnych držiakov pre prevodovku



PLNENIE SO SYSTÉMOM

i  **24**
Ďalšie informácie

150.9261		1/8-27 NPT Ford
150.9262		BMW, Honda, Nissan etc.
150.9263		VAG
150.9264		VAG, Porsche
150.9265		M10 x 1.0 VAG, Mini Cooper
150.9267		M12 x 1.5 Mercedes
150.9268		M24 x 1.5 VAG DSG
150.9269		M22 x 1.5 VAG CVT
150.9271		M18 x 1.5 Skoda
150.9272		M30 x 1.5 VAG, Skoda
150.9273		Universal Flexible 300 mm, Honda, Hyundai, Kia, etc.
150.9274		5/16-24 (UNF) Volvo
150.9276		M18 x 1,5 Toyota / Lexus
150.9277		M8 x 1,0 Nissan / Infinity
150.9278		ATF-Adapter V.W, Passat
150.9562		Nissan Juke M12 x 1,25
150.9563		Mini Cooper M14 x 1,5
150.9564		issan M10 x 1,5
150.9566		GM M12 x 1,75
150.9567		Mercedes 725-9G
150.9102		VAG 7 DSG
150.9103		VAG 7 DSG
150.9104		VAG 7 DSG

VRÁTANE 23-DIELNEJ SÚPRAVY ADAPTÉROV

207,00

150.9105

Systém plnenia prevodového oleja s 23-dielnou súpravou adaptérov





Ďalšie informácie



ČERPADLÁ S VÝKONOM

69,00

NEW



- ideálny na čisté, rýchle a jednoduché odsávanie, nasávanie a vyprázdňovanie kvapalín
- vhodný pre motorový olej, prevodkový olej, hydraulický olej, brzdovú kvapalinu, vodu atď.
- na pneumatické použitie s kompresorom alebo manuálne s integrovanou ručnou pumpou
- odsávanie sa automaticky preruší pri plnom telese, aby nepretiekla žiadna kvapalina
- s integrovaným pretlakovým ventilom pre väčšiu bezpečnosť



160.0865

Vákuové odsávacie čerpadlo 6,5 litrové



Ďalšie informácie



NEW

TVAR: XS FUNKCIA: XL



7,50

150.9597

Nástrčkový orech pre montáž pružiacej jednotky pre vozidlá Tesla



Ďalšie informácie



41,00

115.1056

Kliešte na hadicové spojky na ťahovanie momentom

i  **4**
 Další informace



116,00

Ø 30 mm

McPherson podpera pružiacej jednotky pre zdvihač prevodovky

160.0195

i  **7**
 Další informace



6 mm

104,00

Súprava špeciálneho montážneho náradia pre tlmíč s dorazovou pružinou





1

2

3

4

150.9545

TESTOVANÉ  **PRE VAŠU BEZPEČNOSŤ!**

i  **6**
 Další informace

i

univerzálne pre 90 % všetkých bežných pružín osobných motorových vozidiel a transportérov

Ø 80 - 160 mm

Ø 140 - 195 mm

469,00

- ideálne vhodné na bezpečnú montáž a demontáž pružiacich jednotiek McPherson
- potrebné na výmenu tlmíčov alebo závitových pružín
- univerzálne pre 90 % všetkých bežných pružín osobných motorových vozidiel a transportérov
- nenákladná a solídna alternatíva k bežným napinákom pružín
- vhodné aj pre kuželovité a guľové pružiny
- s certifikáciou TÜV



Technické údaje:	
kapacita pružiny:	2600 kg
Rozpätie max.:	355,0
pružinový tlak max.:	80,0 - 195,0 mm

500.8400 Univerzálna súprava napinákov pružín



Ďalšie informácie

Ø 30 mm

TESTOVANÉ



PRE VAŠU BEZPEČNOSŤ!

387,00

1/2" x 1/2", 100 Nm

Ø 90 - 140 mm



500.8765 Súprava teleskopických strediacich napinákov pre vnútorné pružiny pre Audi a Seat

NA ROZŠÍRENIE



Ďalšie informácie

Ø 95-110 mm

PRE NAPINÁK PRUŽÍN 500.8755 + 500.8765

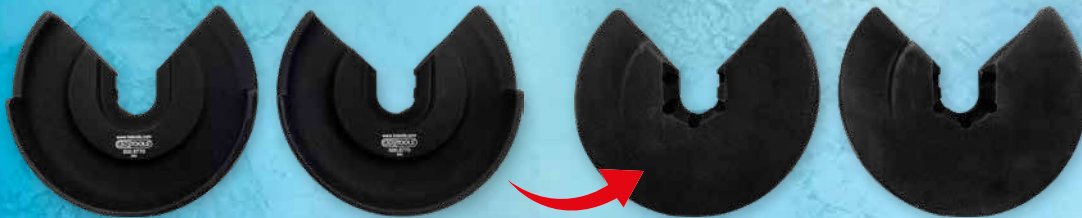

Oblasť použitia: Mercedestrieda E (W211 / W212), trieda C (W204), GLA (X156), GLK (X204), Ford Focus II (MK2), BMW rad 1 (E81), Volkswagen Passat (B6 / 36)

104,00

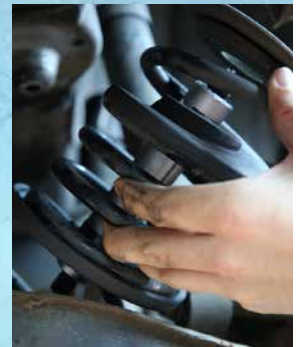

500.8770 Párový držiak pružiny Ø 95-110 mm

NA ROZŠÍRENIE



Ďalšie informácie



Ø 30 mm

Ø 90 - 140 mm

Ø 75 - 115 mm

352,00



500.8755 Súprava univerzálnych teleskopických strediacich napinákov pre vnútorné pružiny

JEDNODUCHÉ UPÍNANIE

i  **1**
 Ďalšie informácie

max 12000 N



1190,00

500.8800 Pneumatický stojanový napínač pružín, max. 10 bar

i  **1**
 Ďalšie informácie

max 24000 N



1660,00

s dvojitým valcom

500.8810 Pneumatický stojanový napínač pružín s dvojitým valcom

PRE 95 % VŠETKÝCH VOZIDIEL

i  **1**
 Ďalšie informácie

- jednoduchá manipulácia
- špeciálna nástrojová oceľ
- ideálny na uchytenie pružiacich jednotiek
- optimálny pre bezpečnú stabilitu pri montáži a demontáži
- so 4 fixačnými čapmi a 4 závitovými čapmi
- dodávka sa realizuje s 2 rozpernými krúžkami na montáž

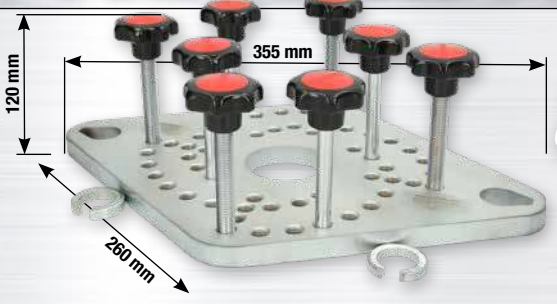

120 mm
355 mm
260 mm

293,00

500.8801 Adaptérová doska pre pneumatický stojanový napínač pružín

SÚPRAVA NAPINÁKOV PRUŽÍN VRÁTANE ADAPTÉROVEJ DOSKY

i  **2**
 Ďalšie informácie

Nástroj na stlačenie vinutej pružiny v pneumatickom stojane vrát. dosky adaptéra



1400,00

500.8805

i  **2**
 Ďalšie informácie

Pneumatický stojanový napínač pružín s dvojitým valcom vrátane adaptérovej dosky



1869,00

500.8815

i  **1**
 Ďalšie informácie

max. 8 bar

450 mm

1/4" PT

pre univerzálne nápravové manžety

104,00

515.3100 Pneumatický montážny prístroj pre nápravové manžety





i  **1**
 Ďalšie informácie

100 mm

255 mm

Ø 30 mm

52,00

150.1850 Univerzálny odťahovač kĺbových hriadeľov





i  **1**
 Ďalšie informácie

41,00

Rozpínacie náradie pre upínací otvor

700.5662

10 mm

UNIVERSAL

5 - 14 mm

max. 25 Nm



i  **6**
 Ďalšie informácie

384,00

Súprava pneumatického kladiva Vibro-Power

515.3880

10 mm

110 mm

10 mm

110 mm

10 mm

130 mm

10 mm

100 x 25 x 12 mm

37x / sec.













Ďalšie informácie

TOP
SELLER



175,00

700.1495 Univerzálna páka nápravy s reťazou

- vďaka flexibilnej reťazi je možné priečne závesné ramená najrozličnejších konštrukcií bezpečne stlačiť bez vynaloženia veľkej sily

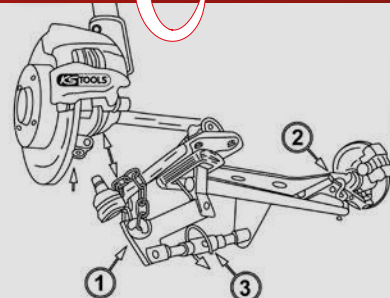

Ďalšie informácie

NEW

- stabilné lichobežníkové závitové vreteno
- nožný pedál na jemné nastavenie (20 mm)
- ideálny pomocník do autodielyne pre rôzne situácie

150,00

max.
680 kg

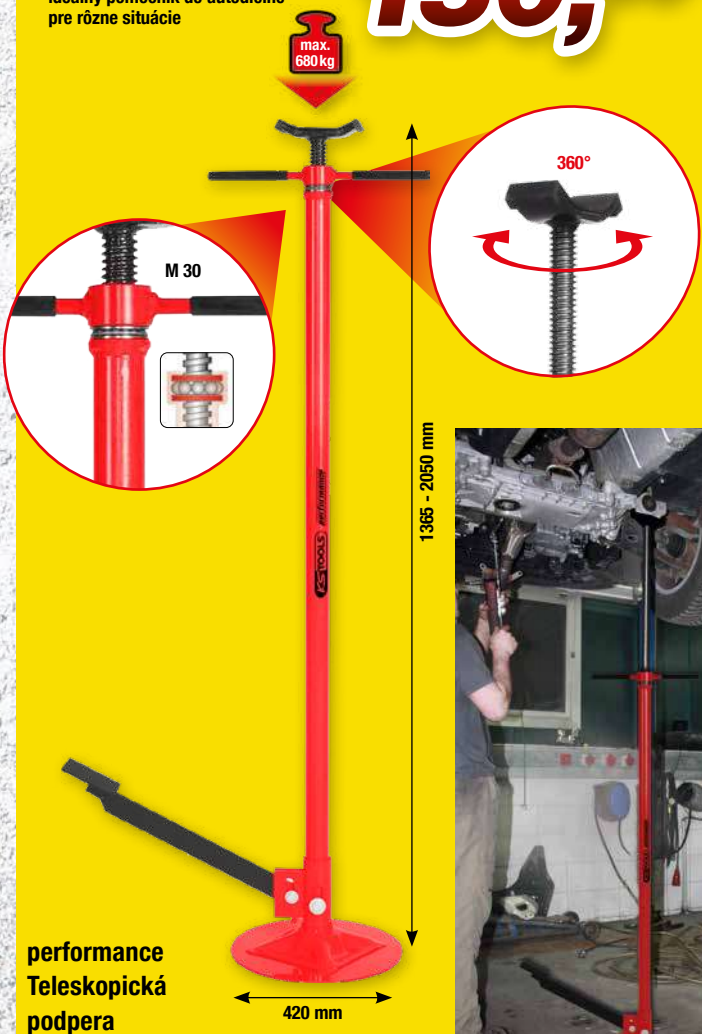

360°

M 30

1365 - 2050 mm

420 mm

performance
Teleskopická
podpera

	max. nosnosť t	min. výška mm	max. výška mm	Dĺžka mm	Šírka mm
160.1265	0,68	1365,0	2050,0	420,0	85,0



Ďalšie informácie



93,00

911.6187 Teleskopická montážna páka s hlavou a kĺbom



Ďalšie informácie

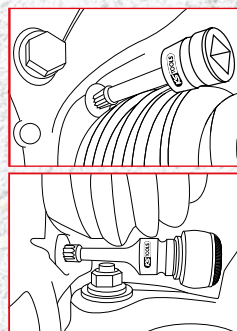

M12

115 mm

72 mm

Súprava špeciálnych
silových nástrčných
bitov pre skrutky s
tisichranom (XZN®)

20,00

515.0595 1/2"



Ďalšie informácie

S RÝCHLYM ZAISTENÍM



1000 WATT



750 mm



469,00

OPTIONAL

500.8605

100 x 100 mm



135,00

500.8440

500.8605

Súprava indukčných teplovzdušných pištolí



Ďalšie informácie



1500 WATT

549,00



NEW

NIEKTO TO RÁD HORÚCE!



770 mm



230 mm

Ø 28/60 mm

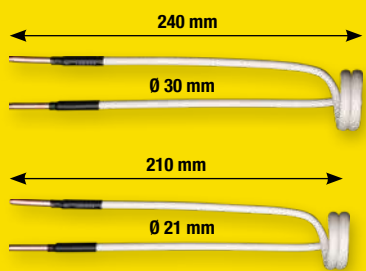

240 mm

Ø 30 mm

210 mm

Ø 21 mm

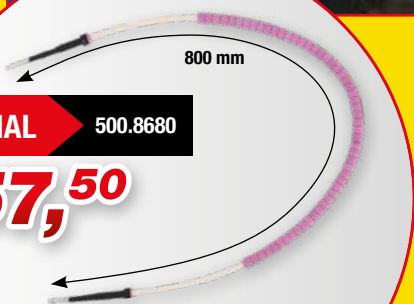

800 mm

OPTIONAL

500.8680

57,50

Indukčná cievka s keramikou ochranou, tvarovateľná

500.8687

500.8680

Súprava indukčných teplovzdušných pištolí



Ďalšie informácie

TOP
SELLER



311,00



4 x



M10x1,5 - M12x2,0
M14x2,0 - M16x2,5

9 x



Ø 38 - 40 - 42 - 50 - 52
54 - 62 - 64 - 66 mm

13 x



Ø 34 - 36 - 44 - 46
48 - 56 - 58 - 60 - 68
70 - 72 - 75 - 80 mm

1 x



Ø1: 34 - 80 mm



Ø2: 44 - 90 mm



2 x



700.1550

Súprava tlakových a ťahových puzdier



Ďalšie informácie



30-35 mm



35-40 mm



40-45 mm



1/2" / 32 mm

360 mm



83,00

150.1125

Súprava špeciálnych kľúčov
pre spojovaciu tyč/axiálny kĺb



Ďalšie informácie

4,3
Kg

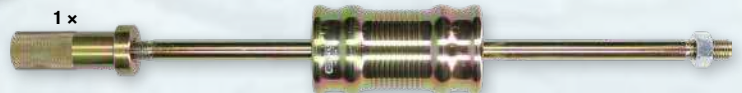

1 x

Ø 90 - 130 mm



3 ✓

1 x



4 x M 14

4 x

M12 x 1,25
M12 x 1,5

4 x

M12 x 1,25
M12 x 1,5
M14 x 1,5

M18 x 2,5 x 230 mm

M57 x 2

1 x



233,00

700.1530

Univerzálna súprava sťahovákov na náboje kolies a kĺbových hriadeľov

**VAŠE VÝHODY PRI VÝMENE KOTÚČOV:
MENEJ PRACOVNEJ SILY, VIAC ÚŽITKU!**

ONE-MAN SHOW PRI VÝMENE KOTÚČOV



**ONE MAN
CUT**

Súprava profesionálnych
ochranných panelov, 4-dielna
2x 270x200 mm + 2x 450x300 mm

Fixácia rezacieho drôtu

Kvalitná
pumpovacia
prísavka

6-hranový pohon, 30 mm

Odľahčovacia
páka

Nosnosť:
110 kg

Zavádzacia
sonda na rezací drôt
na sklo, 290mm

Vratná kladka

Nosnosť:
110 kg

Nasávací tanier
Ø 150 mm

Fixácia rezacieho drôtu

Nasávací tanier
Ø 50 mm

Nasávací tanier
Ø 50 mm

Vratná kladka

nylon, 50 m

Nosnosť: 110 kg
Drôt so štvorcovým
prierezom, 50 m



Ďalšie informácie

Ochranný panel, zahnutý

- ideálne na profesionálne a šetrné odstránenie lepených čelných skiel a väčšiny zadných a bočných skiel
- s veľkou vodiacou kladkou, čo si vyžaduje menej úsilia a minimalizuje riziko pretrhnutia drôtu

- vedenie drôtu priamo pred čelným sklom, čo vo väčšine prípadov eliminuje časovo náročnú demontáž ozdôbnych dielov
- jednoduchá obsluha jednou osobou
- obzvlášť kvalitné prísavky pre bezpečné uchytenie na okno

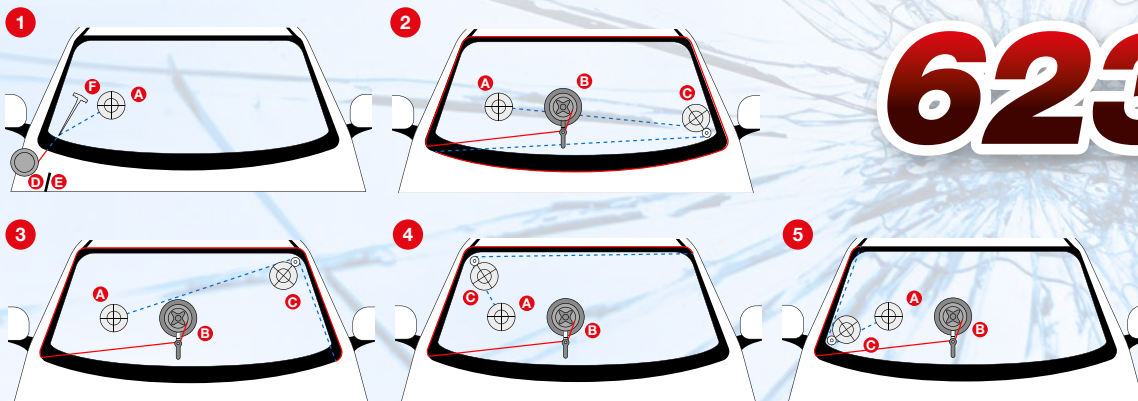

623,00

VRÁTANE



140.2630 Univerzálny prístroj na vyrezávanie čelného skla jedným pracovníkom

i **1**
 Ďalšie informácie

AJ PRE DOT5.1, ENV4 A ENV6

• Dot3 ✓
 • Dot4 ✓

0 20 mm

155 mm

15,00

150.1969 Tester brzdovej kvapaliny pre DOT a ENV

i **1**
 Ďalšie informácie

PUMP IT UP!

29,00

Pumповacia rozprašovacia
 flaša pre čistič brzd

150.8258

TOP SELLER

VITON®
 FKM

Špeciálne pre čistič brzd ✓

i **2**
 Ďalšie informácie

11,00

150.1935 Súprava univerzálnych hákov, tvarovateľné

i **12**
 Ďalšie informácie

1/2" 11,5 mm 14 mm 15 mm 20 mm AS 22 mm

1/4" 9 x 20 mm

3/8" 7 x 72 mm
 7 x 92 mm
 9 x 50 mm
 11 x 100 mm

3/8" 7 x 25 - 8 x 25 mm

52,00

Súprava špeciálnych nástčných orechov pre skrutkové spoje brzdového strmeňa

150.2400 1/4" 3/8" 1/2"

i **41**
 Ďalšie informácie

104,00

Súprava nástrojov na spätné nastavenie piestov brzdového valca

150.1970

BRZDY POD KONTROLOU

i **8**
 Ďalšie informácie

UNIVERSAL

Pre 95 % všetkých vozidiel

2-pinový

3-pinový

3/8"

4-pinový

135,00

150.2440 Univerzálne tlakové/otočné zariadenie

i **1**
 Ďalšie informácie

5L

727,00

160.0700 Prístroj na údržbu brzd KS5

160.0700 Prístroj na údržbu brzd KS5

i **3**
 Ďalšie informácie

TESLA

50,00

NEW

160.0695 Súprava adaptérov na odvzdušňovanie brzd pre vozidlá Tesla



PRE 80 % VŠETKÝCH VOZIDIEL

Ďalšie informácie

1



Ø 90 mm

3

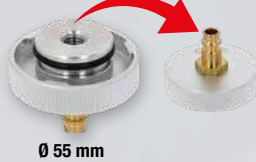

Ø 55 mm

2



Ø 20 - 78 mm

4



E 20

5



0,2 L



79,00

160.0785

Súprava adaptérov na odvzdušňovanie bŕzd

1X PREVZDUŠNIŤ, PROSÍM!



Ďalšie informácie



Mercedes
VAG
BMW
PSA
Volvo
Ford
Fiat
Porsche

1



54 mm



Dong Feng
Fengxing

9



52 mm

2



58 mm

10



40 mm

3



55 mm

Buick

11



42 mm

Wuling

4



55 mm

Audi
Ford
Peugeot

12



50 mm

Suzuki

5



72 mm

Honda

13



55 mm

Soueast

6



52 mm

Toyota

14



59 mm

Nissan

7



54 mm

Buick
Cadillac
Ford
Mazda

15



86 mm

Mitsubishi
Souesat

8



50 mm

Chrysler
Dodge
Jeep

16



56 mm

Tesla



119,00



17



Ø 27 mm

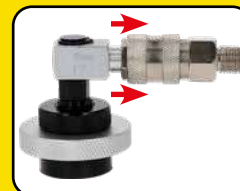

160.0815

Univerzálna súprava adaptérov na odvzdušňovanie bŕzd

i   **1**

Ďalšie informácie

52,00

Max. 70 mm
Min. 28 mm

univerzálne nastaviteľný

160.0718 Univerzálne tlakové/otočné zariadenie

TOP SELLER

i   **1**

Ďalšie informácie

3V1

1 OHÝBANIE
2 DUPLIKOVANIE
3 VYROVNANIE

4,75 mm (3/16")
6,35 mm (1/4")

31,00

Vyrovňavacie/ohýbacie náradie na brzdové vedenia, 4,75 mm (3/16") + 6,35 mm (1/4")

120.1004

i   **1**

Ďalšie informácie

TOYOTA & LEXUS

7,2 mm

1 + 2

17,00

160.0719 Univerzálny adaptér pre odvzdušňovacie hrdlo pre Toyota a Lexus

DOKONALÉ PREVZDUŠNENIE!

i   **6**

Ďalšie informácie

1.200 mm

72,00

11 mm
10 mm
9 mm
8 mm
7 mm

160.0725 Súprava kľúčov na odvzdušňovaciu skrutku pre brzdy

i   **11**

Ďalšie informácie

STOP

1.200 mm

9x12 mm

180 mm

11 mm
10 mm
11 mm
7 mm
11 mm
10 mm
11 mm
85 mm

78,00

518.0320 Súprava kľúčov na odvzdušňovaciu skrutku pre brzdy pre VAG

TOP SELLER

		DIN	SAE	4,75 mm	5,0 mm	6,0 mm	s ohýbačkou rúrok	s rezačkou rúrok	s odhrotovačom	mechanický	s hydraulickým vretenom	ručná pumpa	v kufri
1	122.1215	✓	✗	✓	✗	✗	✗	✗	✗	✓	✗	✗	✗
2	122.1290	✓	✓	✓	✓	✓	✓	✓	✓	✗	✓	✗	✓
3	122.1260	✓	✓	✓	✓	✓	✗	✗	✗	✗	✗	✓	✓

1

FLAREFIX eco

52,00

FLAREFIXeco 4,75 mm súprava univerzálnych lemovacích prístrojov pre brzdové vedenia

122.1215

Ďalšie informácie

4

STOP

3/8" DIN M12x1,25

PATENT

Special Punch Grosse für Hartmetall

4,75 mm

2

FLAREFIX

176,00

Master súprava univerzálnych obrubovacích prístrojov

122.1290

Ďalšie informácie

16

max. 2t

DIN SAE

4,75(3/16") 5 / 6mm

3,0-12,0 mm

3,0-6,0 mm

3,0-16,0 mm

4,75-5,0 mm, SAE

6,0 mm, SAE

4,75-5,0-6,0 mm, SAE-90°

4,75-5,0 mm, DIN

6,0 mm, DIN

M12x1,25

4,75 mm, 3/16"

5,0 mm

6,0 mm

NAJLEPŠIA VOĽBA: JEDNODUCHO UNIVERZÁLNY

3

FLAREFIX II Hydraulic

311,00

FLAREFIX 2 univerzálna súprava obrubovačiek na brzdové vedenia s hydraulickým valcom

122.1260

Ďalšie informácie

11

DIN SAE

4,75(3/16") 5 / 6mm

max. 2t

M12 x 1,25 mm

4,75-5,0 mm, SAE

6,0 mm, SAE

4,75-5,0-6,0 mm, SAE-90°

4,75-5,0 mm, DIN

6,0 mm, DIN

M12x1,25

4,75 mm, 3/16"

5,0 mm

6,0 mm



Ďalšie informácie



3/8"



1 Ford/PSA



2 BMW



3 VAG



4 Mercedes



5 DAF/MAN



6 GM



7 Ford



8 Ford



9 Ford

26,00

3/8" súprava špeciálnych profilov na výmenu oleja pre plastové vypúšťacie skrutky oleja, 9 ks

150.1040



Ďalšie informácie

8,50

Ø 340 mm

6 LITROV



120 mm

1

150.9593

Zachytávacia vaňa 6 litrov



Ďalšie informácie

13,00

Ø 385 mm

7,5 LITROV



130 mm

2

150.9359

Zachytávacia vaňa 7,5 litrov



Ďalšie informácie

VAŇA NIKDY NIE JE PLNÁ!

NEW

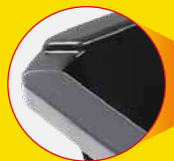

50 LITROV

595 mm

875 mm

110 mm

35,00

3

150.9592

Zachytávacia vaňa na olej / viacúčelová vaňa, 50 litrov

i  **1**
 Ďalšie informácie

NEW

25,00

1/2"

63,8 mm

14

150.9469 **Tesla Klúč na olejový filter**

i  **30**
 Ďalšie informácie

104,00

1/2" 21 mm

Ø 63 - 102 mm

3/8"

65-14, 65/67-14, 66-6, 68-14, 73-14, 74-15, 74/76-15, 75/77-15, 76-8, 76-12, 76-14, 76-30, 78-15, 80-15, 80/82-15, 86-18, 86-16, 90-15, 92-10, 93-15, 93-36, 93-45, 95-15, 96-18, 100-15, 106-15, 108-15, 108-18

150.9350 **3/8" súprava kľúčov na olejový filter**

i  **24**
 Ďalšie informácie

104,00

TOP SELLER

VW Lexus Lotus Ford Nissan
 Subaru Mitsubishi Land Rover Hyundai Audi
 Chrysler Toyota Citroën Volvo Cadillac
 Citroën Buick Volvo Buick univerzálny

2,0 L

150.9130 **MASTER Súprava lievnikov na plnenie oleja s otočným ramenom**

i  **4**
 Ďalšie informácie

PRE VAG

s otočným uhlovým ramenom
 pre ťažko dostupné miesta

15,00

2,0 L

150.9155 **Súprava lievnikov na plnenie oleja s otočným ramenom pre VAG**

i **1**
 Ďalšie informácie

200 kg

1.385 mm

695 mm

Ø 550 - 750 mm

195,00

160.0070 performance Profesionálny vozík na pneumatiky

i **1**
 Ďalšie informácie

680 kg

max. 300 mm

345 - 660 mm

AL 225,00

HYDRAULICKÝ max. 750 mm max. 300 mm

A

160.1205

i **1**
 Ďalšie informácie

680 kg

max. 330 mm

325 - 725 mm

AL 185,00

MECHANICKÝ max. 330 mm max. 330 mm

B

160.1210

performance úložný podstavec so štyrmi pomôckami pre manévrowanie

A HYDRAULICKÝ

B MECHANICKÝ

od **785,00**

4x

A	160.1220		hydraulický	930,00 €
B	160.1225		mechanický	785,00 €

i **1**
 Ďalšie informácie

performance Hydraulický fľaškový zdvihák

max. 50 t

od 30,00

	max. zdvíhacie zaťaženie t	min. A mm	max. A mm	B mm	C x D mm	
160.1100	2,0	170,0	315,0	145,0	95 x 80	30,00 €
160.1105	5,0	205,0	400,0	195,0	120 x 100	40,00 €
160.1110	10,0	220,0	445,0	225,0	125 x 105	45,00 €
160.1115	16,0	225,0	455,0	230,0	140 x 120	60,00 €
160.1120	20,0	235,0	445,0	210,0	155 x 125	75,00 €
160.1125	30,0	275,0	440,0	165,0	175 x 150	130,00 €
160.1130	50,0	265,0	425,0	160,0	210 x 175	185,00 €

SPOJAZDNÍ AUTÁ ZA PÁR SEKUND!

i **2** **performance** Ocelový podstavec s rychlým prestavením, pár

Ďalšie informácie

od 40,00

DODÁVKA V PÁROCH

max. 12 t

	max. nosnosť t	min. A mm	max. A mm	B mm	C mm	
160.1245	2,0	280,0	420,0	195,0	170,0	40,00 €
160.1250	3,0	290,0	430,0	200,0	175,0	50,00 €
160.1255	6,0	390,0	610,0	285,0	250,0	90,00 €
160.1260	12,0	500,0	760,0	330,0	300,0	200,00 €

i **2** **AL 4,2! 3 t**

Ďalšie informácie

DODÁVKA V PÁROCH

130,00

260-390 mm

185 mm

165 mm

performance hliníkový podstavec, pár

160.1240

VYSOKO KVALITNE SPRACOVANÉ ✓

NYLONOVÉ KOLIESKA ✓

GUMENÝ TANIER ✓

JEMNÉ UVOLNENIE ✓

POGUMOVANÁ OCHRANA PROTI NÁRAZU ✓

i **1** **AL 14! kg**

Ďalšie informácie

165,00

1,5 t

90 mm

240 mm

555 mm

- 360 mm MAX HÖHE/ HEIGHT
- 5pumps
- 270 mm
- SAFETY OIL-BYPASS-TECHNOLOGY
- 82x6 mm

performance Hydraulický hliníkových zdvihák

160.1000

i **1** **AL 27! kg**

Ďalšie informácie

240,00

2,5 t

100 mm

310 mm

665 mm

- 450 mm MAX HÖHE/ HEIGHT
- 7pumps
- 350 mm
- SAFETY OIL-BYPASS-TECHNOLOGY
- 96x7 mm

performance Hydraulický hliníkových zdvihák

160.1005

ODLIŠUJE SA OD KONKURENCIE



Ďalšie informácie

245,00



3 t

456 mm
MAX
HÖHE/
HEIGHT

6,5 pumps

336 mm

with the AbsorbFunction
with lowering function

SAFETY
OIL-BYPASS-
TECHNOLOGY

110x9 mm

performance
Hydraulický ocelový zdvihák

160.1010



Ďalšie informácie

250,00



2,5 t

510 mm
MAX
HÖHE/
HEIGHT

7 pumps

435 mm

with the AbsorbFunction
with lowering function

SAFETY
OIL-BYPASS-
TECHNOLOGY

110x9 mm

performance
Hydraulický ocelový zdvihák

160.1015



Ďalšie informácie

270,00



3 t

510 mm
MAX
HÖHE/
HEIGHT

7 pumps

435 mm

with the AbsorbFunction
with lowering function

SAFETY
OIL-BYPASS-
TECHNOLOGY

110x9 mm

performance
Hydraulický ocelový zdvihák

160.1020

performance

SLÁVA TÝMTO ZDVIHÁKOM!

i   **1**
Ďalšie informácie

610 mm
MAX
HÖHE/
HEIGHT

5pumps

535 mm

SAFETY
OIL-BYPASS-
TECHNOLOGY

110x9 mm

IBA
75
mm

2 t

75 mm

380 mm

875 mm

485,00

performance
160.1025 Hydraulický ocelový zdvihák

i   **1**
Ďalšie informácie

510 mm
MAX
HÖHE/
HEIGHT

4pumps

440 mm

SAFETY
OIL-BYPASS-
TECHNOLOGY

92x5,5 mm

IBA
70
mm

3 t

70 mm

365 mm

805 mm

565,00

performance
160.1030 Hydraulický ocelový zdvihák

i   **1**
Ďalšie informácie

510 mm
MAX
HÖHE/
HEIGHT

7pumps

425 mm

SAFETY
OIL-BYPASS-
TECHNOLOGY

110x9 mm

IBA
85
mm

3 t

85 mm

360 mm

740 mm

410,00

performance
160.1035 Hydraulický ocelový zdvihák

i   **1**
Ďalšie informácie

540 mm
MAX
HÖHE/
HEIGHT

8pumps

445 mm

SAFETY
OIL-BYPASS-
TECHNOLOGY

116x8,5 mm

IBA
95
mm

3,5 t

95 mm

345 mm

760 mm

445,00

performance
160.1040 Hydraulický ocelový zdvihák

i **Ďalšie informácie**

5 t **570,00**

4 t

350-710 mm

65-405 mm

720 mm

260 mm

performance
Zdvihák pre vysokozdvížný vidlicový vozík, hydraulický

160.1050

i **Ďalšie informácie**

od 895,00 **max. 10 t**

A

B

C

D

performance
Hydraulický ocelový zdvihák

performance
Hydraulický ocelový zdvihák

		max. zdvihacie zaťaženie t	min. A mm	max. A mm	B mm	C mm	D mm	
160.1060		5,0	150,0	685,0	535,0	1510,0	365,0	895,00 €
160.1065		10,0	160,0	560,0	400,0	1640,0	495,0	1135,00 €

i **Ďalšie informácie**

od 855,00 **max. 80 t**

A

B

C

D

performance Vzduchovo-hydraulický zdvihák

		max. zdvihacie zaťaženie t	min. A mm	max. A mm	B mm	C mm	D mm	
160.1075		32 / 16	150,0	295,0	145,0	900,0	290,0	855,00 €
160.1080		40 / 25 / 15	125,0	300,0	175,0	920,0	285,0	1045,00 €
160.1085		40 / 20 / 15 / 10	100,0	275,0	175,0	920,0	300,0	1120,00 €
160.1090		80 / 40	195,0	380,0	185,0	645,0	345,0	975,00 €

NA ROZŠÍRENIE

i **Ďalšie informácie**

120,00 **2 t**

120 mm

710 mm

obojstranne rozťahnutelný

performance Priečka pre zdvihák na autá

160.1045

performance Hydraulický dielenský lis

20 t

1650 mm

760 mm

750 mm

860,00

160.1150

performance Hydraulický dielenský lis

30 t

1800 mm

760 mm

810 mm

1405,00

160.1155

performance Hydraulický dielenský lis

50 t

1900 mm

1010 mm

810 mm

2050,00

160.1160

performance ochranná mriežka pre hydraulický dielenský lis

od **155,00**

	Použitie pre	Dĺžka mm	Šírka mm	
160.1151	160.1150	600,0	500,0	155,00 €
160.1156	160.1155	600,0	500,0	165,00 €
160.1161	160.1160	600,0	690,0	185,00 €

performance súprava prítlačných trňov pre hydraulický dielenský lis

125,00

- 10 x 50 mm 2t
- 12 x 60 mm 3t
- 16 x 60 mm 8t
- 18 x 85 mm 12t
- 20 x 85 mm 14t
- 22 x 85 mm 16t
- 25 x 110 mm 18t
- 30 x 110 mm 20t

160.1165

performance Teleskopická podpera

680 kg

360°

85 mm

M 30

1365 - 2060 mm

420 mm

150,00

160.1265

performance Hydraulický zdvihák prevodovky

500 kg

815 mm

1110 - 1925 mm

630 mm

255,00

160.1270

performance Hydraulický zdvihák prevodovky so stolom

500 kg

990 mm

770 mm

985,00

900 - 1890 mm

160.1305

VHODNÉ DO JÁM PRE VOZIDLÁ

i  **1**
 Ďalšie informácie



1 t

530 mm 930 mm 190-770 mm

960,00

performance
 Hydraulický zdvihák prevodovky s nastaviteľnou upínacou doskou

160.1330

i  **1**
 Ďalšie informácie



1,5 t

655 mm 1085 mm 220-940 mm

1235,00

performance
 Hydraulický zdvihák prevodovky s nastaviteľnou upínacou doskou

160.1335

i  **1**
 Ďalšie informácie



1 t

790 mm 925 mm 895-1820 mm

1045,00

performance
 Hydraulický zdvihák prevodovky so stolom

160.1310

i  **1**
 Ďalšie informácie



2 t

950 mm 1085 mm min. 190 - max. 2380 mm

495,00

performance dielenský žeriav, skladací

160.1290

i  **1**
 Ďalšie informácie



680 kg

70,00

performance
 Zariadenie na polohovanie bremien

160.1291

i **1**
 Další informace

680 kg

890 mm
825 mm
900 mm

195,00

160.1285 performance Držák motoru

i **1**
 Další informace

PREMOSTENIE, TAKÉ JEDNODUCHÉ!

1550 mm
320 mm
500 kg

75,00

160.0265 performance Mostík na motor

i **1**
 Další informace

35 kg

740 mm
760 mm
950 - 1300 mm

prestavitelný

Vodiace koliesko s brzdou

175,00

160.0215 performance Univerzálny odkladací stół, výškovo nastaviteľný

i **1**
 Další informace

200 kg

200 kg

65,00

160.0216 performance podlahová doska

NA ROZŠÍRENIE

NA PREPRÁVU PNEUMATÍK ALEBO OLEJOVÝCH SUDOV



i  **1**
 Další informace

465,00

500 kg



max. 600 mm
275 - 875 mm
500 mm
935 mm

performance
 160.1315 **Hydraulický úložný stůl pojazdný**

i  **1**
 Další informace

195,00

250 kg



240 - 570 mm
250 mm
700 mm
1160 mm



160.0255 performance Zdvihák kolies pre nákladné vozidlá

i  **1**
 Další informace

**VÁŠ OSOBNÝ
 LIFTBOY!**

700 kg



895 mm
190 mm
1160 mm
1090 mm



659,00

160.1200 performance Hydraulický zdvihák na pneumatiky



Ďalšie informácie

HVIEZDY PRE KAŽDÚ PRÍLEŽITOSŤ

GUMENÁ PODLOŽKA VYROBENÁ Z PLNEJ GUMY

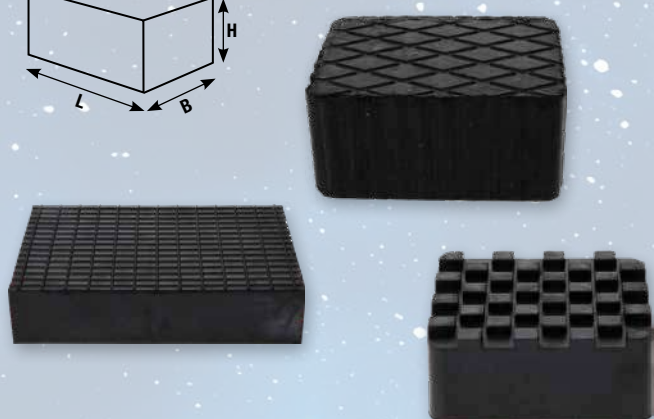
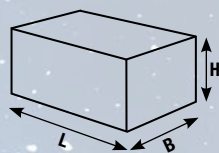

		Počet dielov	L mm	B mm	H mm	
	160.0476	1	160	120	20	5,00 €
	160.0477	1	160	120	30	7,00 €
	160.0478	1	160	120	40	9,00 €
	160.0479	1	160	120	60	13,00 €
	160.0480	1	160	120	80	17,00 €
	160.0481	1	160	120	100	21,00 €
	160.0482	1	160	120	115	25,00 €
	160.0483	1	116,5	116,5	36,5	6,00 €
	160.0499	1	160	120	85	18,00 €
	160.0507	1	120	100	50	6,00 €
	160.0527	1	160	120	20	5,00 €
	160.0547	1	220	140	50	16,00 €

GUMENÁ PODLOŽKA VYROBENÁ Z PLNEJ GUMY

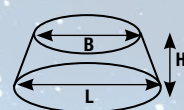
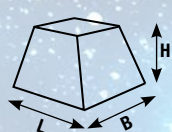

		Počet dielov	L mm	B mm	H mm	
	160.0439	1	120	120	100	10,00 €
	160.0485	1	105	78	60	10,50 €
	160.0503	1	150	150	70	14,00 €
	160.0513	1	150	150	60	11,00 €
	160.0514	1	150	150	50	10,00 €
	160.0518	1	150	150	100	20,00 €
	160.0524	1	150	150	140	27,00 €
	160.0548	1	135	100	30	6,00 €
	160.0552	1	160	120	90	16,00 €
	160.0605	1	135	100	70	15,00 €
	160.0609	1	120	120	60	10,00 €
	160.0616	1	135	135	42	12,00 €
	160.0617	1	140	100	60	10,00 €
	160.0618	1	140	100	120	16,00 €

GUMENÁ PODLOŽKA PRE ZDVIŽNÉ PLOŠINY

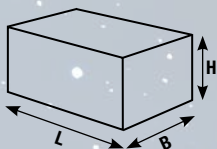

		Počet dielov	L mm	B mm	H mm	
	160.0531	1	400	350	12	20,00 €
	160.0586	1	360	260	12	45,00 €
	160.0604	1	460	300	30	105,00 €
	160.0598	1	104	82	8	2,00 €

POMÔCKA PRE VÝJAZD PRE ZDVIŽNÉ PLOŠINY

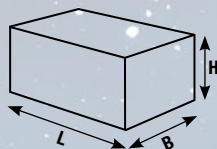

		Počet dielov	L mm	B mm	H mm	
	160.0565	1	1000	500	30	80,00 €
	160.0566	1	1000	500	40	98,00 €
	160.0567	1	1000	500	50	109,00 €
	160.0607	1	500	500	40	60,00 €

OCHRANNÝ BLOK Z PE (POLYETYLÉN)

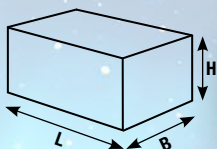

		Počet dielov	L mm	B mm	H mm	
	160.0437	1	250	150	55	15,00 €
	160.0438	1	250	150	100	28,00 €
	160.0486	1	340	150	55	20,00 €
	160.0489	1	340	130	100	33,00 €
	160.0595	1	1350	140	45	55,00 €
	160.0596	1	1350	140	105	105,00 €

GUMENÁ PODLOŽKA PRE KOZLÍKY

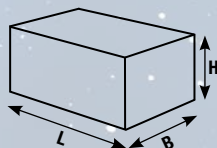

	Počet dielov	L mm	B mm	H mm	
160.0568	1	89	53	48	7,00 €

GUMENÁ PODLOŽKA S DRÁŽKOU

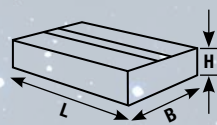

	Počet dielov	L mm	B mm	H mm	
160.0484	1	373	100	35	41,00 €

GUMENÁ PODLOŽKA PRE POJAZDNÝ ZDVIHÁK

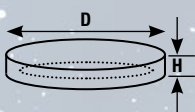

		Počet dielov	D mm	H mm	
	160.0562	1	65	42	Univerzálna gumená podložka pre pojazdný zdvihák, prah dveri 7,00 €
	160.0564	1	67	33	Gumená podložka pre BMW/Mini/Opel/Mercedes 7,00 €
	160.0569	1	66	32	Gumená podložka pre Audi 7,00 €
	160.0570	1	78	43	Gumená podložka pre Mercedes 7,00 €

SÚPRAVA GUMENÝCH PODLOŽIEK VYROBENÝCH Z PLNEJ GUMY

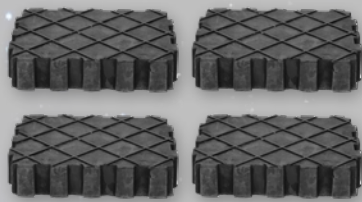

	Počet dielov	L mm	B mm	H mm	
160.0391-TD	4	155	125	35	36,00 €

SÚPRAVA PUZDIER PRE ZDVIHÁKY



- Model 3 ✓
- Model S ✓
- Model X ✓
- Model Y ✓



	Počet dielov		
160.0460	4	Tesla Model 3, S, X, Y	25,00 €

GUMOVÁ PODLOŽKA S OCEĽOVOU DOSKOU

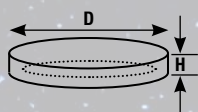

OCEĽOVÁ DOSKA





	D mm	H mm	AMI	ATH	Autop	BEISSBARTH	CE-300	Consul	Ebing	Herrmann	HOFMANN	HTC	IMED	J.A. Becker	MAHA	MWH	Mussbaum	Ravaglioli	Sift	Stenhoj	Werther	Zippo			
	160.0444	123	15																				✓	8,00 €	
	160.0463	120	22												✓										9,00 €
	160.0465	123	25															✓				✓			9,00 €
	160.0475	120	19		✓					✓	✓			✓											9,00 €
	160.0504	121	10			✓																✓			8,00 €
	160.0516	127	28	✓													✓		✓						8,00 €
	160.0517	130	30	✓													✓		✓						8,00 €
	160.0533	123	16			✓																✓			8,00 €
	160.0536	137	18					✓								✓									10,00 €
	160.0541	123	24															✓				✓			8,00 €
	160.0555	135	20				✓	✓		✓													✓		8,00 €
	160.0574	153	32				✓		✓														✓		13,00 €
	160.0575	150	15																				✓		11,00 €

		D mm	H mm	AMI	ATH	Autop	BEISSBARTH	CE-300	Consul	Ebing	Herrmann	HOFMANN	HTC	IMED	J.A. Becker	MAHA	MWH	Nussbaum	Ravaglioli	Slift	Stenhoj	Werther	Zippo		
	160.0576	100	15																					✓	8,00 €
	160.0583	155	15											✓						✓					8,00 €
	160.0584	122	12,5											✓						✓					8,00 €
	160.0588	158	11,5			✓															✓				10,00 €
	160.0608	135	75				✓		✓														✓		16,00 €

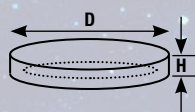
GUMOVÁ PODLOŽKA S OCELOVÝM KRÚŽKOM

OCEĽOVÝ KRÚŽOK









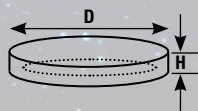





















		D mm	H mm	AMI	ATH	Autop	BEISSBARTH	CE-300	Consul	Ebing	Herrmann	HOFMANN	HTC	IMED	J.A. Becker	MAHA	MWH	Nussbaum	Ravaglioli	Slift	Stenhoj	Werther	Zippo		
	160.0543	127	21																					✓	3,00 €
	160.0546	130	17								✓														3,00 €
	160.0551	160	21									✓													4,00 €
	160.0559	140	18									✓													4,00 €















GUMOVÁ PODLOŽKA

GUMA



		D mm	H mm	AC	Adami	AGM	ATH	Cascos	ETG	EVER ETERNAL	Grazia	Herrmann	HOFMANN	HTC	Intertech	Isobal	J.A. Becker	Koni	Launch	MAHA	Nordlift	Nussbaum	OMCN	Ravaglioli	Rometco	Rotary	RP Tools	Sirio	Slift	Space	Twin Busch	Velyen	Omegaheber		
	160.0440	123	24																					✓											4,00 €
	160.0464	120	23																	✓															5,00 €
	160.0466	125	24																			✓													12,00 €



		D mm	H mm	AC	Adami	AGM	ATH	Cascos	ETG	EVER ETERNAL	Grazia	Herrmann	HOFMANN	HTC	Intertech	Isobal	J.A. Becker	Koni	Launch	MAHA	Nordlift	Nussbaum	OMCN	Ravaglio	Romeico	Rotary	RP Tools	Sirio	Sift	Space	Twin Busch	Veyen	Omegaheber		
	160.0467	140	25																																6,00 €
	160.0468	100	14																					✓			✓			✓					5,00 €
	160.0469	120	32															✓								✓									8,00 €
	160.0470	150	23																					✓											5,00 €
	160.0471	140	30																														✓		8,00 €
	160.0472	130	14																					✓			✓		✓						7,00 €
	160.0473	120	30																														✓		7,00 €
	160.0474	120	19				✓					✓	✓				✓																		5,00 €
	160.0490	100	21																					✓											4,00 €
	160.0491	120	26							✓														✓											5,00 €
	160.0492	120	26																					✓											5,00 €
	160.0493	145	24																					✓	✓										8,00 €
	160.0494	145	26																					✓											7,00 €
	160.0495	160	28												✓																				7,00 €
	160.0496	140	25																					✓											8,00 €
	160.0497	150	25																					✓	✓										6,00 €
	160.0498	140	28																					✓											9,00 €
	160.0508	120	18,5																	✓								✓							3,00 €
	160.0519	160	27					✓						✓	✓		✓								✓										5,00 €
	160.0534	120	20													✓																			5,00 €
	160.0535	123	20,5																							✓									3,00 €
	160.0544	120	40																			✓													9,00 €
	160.0549	109	27,5														✓																		3,00 €
	160.0553	127	22																		✓														3,00 €
	160.0554	139	26,5		✓																														5,00 €

		D mm	H mm	AC	Adami	AGM	ATH	Cascos	ETG	EVER ETERNAL	Grazia	Herrmann	HOFMANN	HTC	Intertech	Isobal	J.A. Becker	Koni	Launch	MAHA	Nordlift	Nussbaum	OMCN	Ravaglioli	Romeico	Rotary	RP Tools	Sirio	Slift	Space	Twin Busch	Veylen	Omegaheber		
	160.0557	125	12,6																							✓								3,00 €	
	160.0571	100	15,5																													✓		4,00 €	
	160.0577	105	17,5	✓																														3,00 €	
	160.0585	124	16,5														✓																	2,00 €	
	160.0587	140	22																													✓		8,00 €	
	160.0589	115	20														✓																	5,00 €	
	160.0590	100	17																	✓														2,00 €	
	160.0591	100	20																				✓			✓	✓							3,00 €	
	160.0593	124	22																					✓										3,00 €	
	160.0594	140	25					✓																										5,00 €	
	160.0597	145	7													✓																✓		3,00 €	
	160.0599	110	20	✓																														5,00 €	
	160.0601	143	26,5																					✓											8,00 €
	160.0603	130	32							✓																								9,00 €	

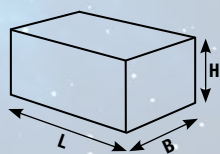
GUMOVÁ PODLOŽKA



GUMA

		L mm	B mm	H mm	AC	HOFMANN	MAHA	Romeico	Rotary	UNIVERSAL		
	160.0525	162	92	25		✓						5,00 €
	160.0528	150	80	28				✓				5,00 €
	160.0529	120	120	25						✓		3,00 €
	160.0561	112	61	17	✓		✓		✓			3,00 €
	160.0602	128	89	35					✓			7,00 €

i **7**
 Další informace

NEW

14" \varnothing 17 mm \varnothing 20 mm

140 mm 197 mm 65 mm 100 mm

29,00

100.5100 Súraava nástrojov na čistenie sediel ventilov pre hliníkové disky

i **1**
 Další informace

8,00

800.0156 Miska magnetická, z plastu, \varnothing 150 mm

i **1**
 Další informace

NEW

Ďalšie radirovacie taniere nájdete na strane 61

\varnothing 60 mm \rightarrow \varnothing 68 mm

[RUBB EX]
 BY **KS TOOLS**

12,50

515.5471 Radirovací tanier na hliníkové disky, kónický

i **1**
 Další informace

0 - 10 bar

400 mm

✓
CIACHOVANÝ

64,00

515.1960 Ciachovaný tlakomer na meranie tlaku v pneumatikách

i **1**
 Další informace

0 - 12 bar

600 mm

1/4" PT

20,00

515.1950 Tlakomer na meranie tlaku v pneumatikách

i **6**
 Další informace

CENA SÚPRAVY = 6X

60,00

515.5476

NEW

i **5**
 Další informace

59,00

150.1070 Súraava na vulkanizáciu pneumatík pre vozidlá vrátane 100 mm vlákná

60 x 100 mm

70 g

9 mm

VOLITELNÉ
 60 kusov

18,00

150.1072

-
-
-
-
-
-
-

PRE ABSOLÚTNE BRILANTNÝ VÝKON!

i  **7**
 Ďalšie informácie

25,00

VOLITEĽNÉ

100.5085 Súprava brúsok na náboje kolesa s podporným čapom, Ø 40 mm

100.5087 Ø 40 mm  6x 20,00 €





Predtým:

Potom:

i  **7**
 Ďalšie informácie

49,00

VOLITEĽNÉ

100.5090 Súprava brúsok na náboje kolesa s podporným čapom, Ø 50 / 60 mm

100.5091	Ø 50 x 12 mm	 10x	25,00 €
100.5092	Ø 50 x 13 mm	 10x	25,00 €
100.5093	Ø 50 x 14 mm	 10x	25,00 €
100.5094	Ø 60 x 16 mm	 10x	40,00 €
100.5096	Ø 60 x 22 mm	 10x	40,00 €
100.5097	Ø 60 x 28 mm	 10x	40,00 €





Predtým:

Potom:

i  **2**
 Ďalšie informácie

93,00

VOLITEĽNÉ

100.5080 Súprava hliníkovej brúsky na náboje kolesa, Ø 150 mm, vnút. Ø 90 mm

100.5077 Ø 150 mm  1x 36,00 €





Predtým:

Potom:

i  **11**
 Další informace



S vyhlášením o zhode pre kalibráciu
 DIN EN ISO 6789
Certifikát
 Presnosť +/-3%

KALIBRIER-KONFORMITÄTSEKLÄRUNG
 DECLARATION OF CONFORMANCE / DECLARATION DE CONFORMITÉ

KALIBRIER-KONFORMITÄTSEKLÄRUNG	
Produktname	...
Produkttyp	...
Norm	...
Hersteller	...
Hersteller-Adresse	...
Hersteller-Telefon	...
Hersteller-E-Mail	...
Hersteller-Web	...
Hersteller-PLZ	...
Hersteller-Stadt	...
Hersteller-Land	...
Hersteller-Reg.-Nr.	...
Hersteller-Reg.-Ort	...
Hersteller-Reg.-Land	...
Hersteller-Reg.-Nr.	...
Hersteller-Reg.-Ort	...
Hersteller-Reg.-Land	...
Hersteller-Reg.-Nr.	...
Hersteller-Reg.-Ort	...
Hersteller-Reg.-Land	...



124,00

516.2400 1/2" 10 - 13 - 17 - 19 - 21 - 24 mm

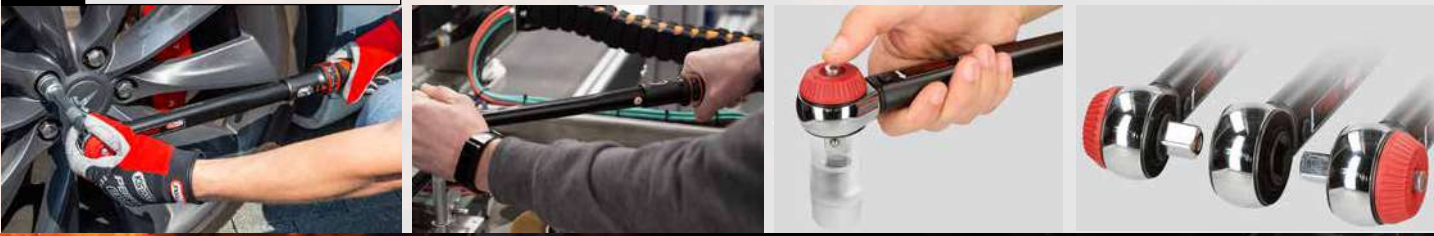

i  **12**
 Další informace

**DIABOLSKY DOBRÉ!
 PEKELNE LACNÉ!**

**TOP
 SELLER**



+



+ 4x

199,00



+



S vyhlášením o zhode pre kalibráciu
 DIN EN ISO 6789
Certifikát
 Presnosť +/-3%

KALIBRIER-KONFORMITÄTSEKLÄRUNG
 DECLARATION OF CONFORMANCE / DECLARATION DE CONFORMITÉ

515.2101



Sprava na demontáž poistných skrutiek

Ďalšie informácie

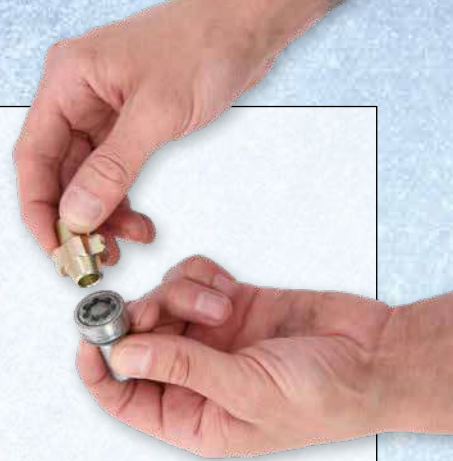

i s ochranou rúk



14 mm

pena

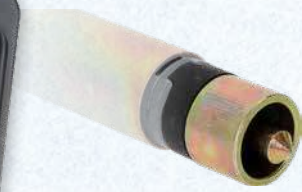

∅ 21,5 mm



∅ 21,5 mm



∅ 16 mm

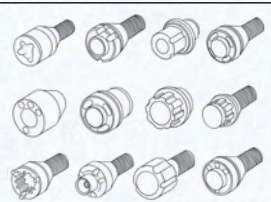

∅ 10,5 mm



∅ 9,5 mm

145,00



použiteľný obojstranne



VOLITELNÉ

7,00

913.1431



152 mm

143 mm

38 mm

1/2"

24 mm

3x

∅ 25 mm

∅ 30 mm



913.1430

UNIVERZÁLNE DÔMYSELNÉ - PRISPÔBIA SA KAŽDÉMU PROFILU!



Ďalšie informácie

Súprava na demontáž
zaistení kolies

913.1480 18 - 19 - 20 - 21 - 22 - 23 - 24 - 25 mm

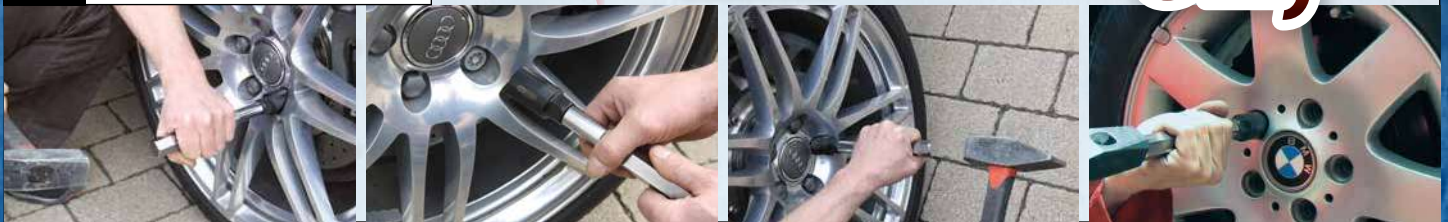

62,00

ZLOMENÉ SKRUTKY?

ŽIADNY PROBLÉM!



Ďalšie informácie



41,00

1/2" súprava silových nástrčných
orechov so špirálovým profilom,
3-dielna, 17-21mm

913.1270 1/2" 17 - 19 - 21 mm



Ďalšie informácie



29,00

Súprava špeciálnych silových nástrčných
orechov pre hliníkové disky pre Ford,
18,5 / 19,5 / 20,5 / 21,5 mm

515.0895 1/2" 18,5 - 19,5 - 20,5 - 21,5 mm



Ďalšie informácie



35,00

515.0850 1/2" 16,5 - 17,5 - 18,5 - 19,5 - 20,5 - 21,5 mm

Súprava špeciálnych silových nástrčných orechov pre hliníkové disky

i **3**

Ďalšie informácie

17 mm 17 mm 17 mm

85 mm

12,50

515.0860 1/2" 3 x 17 mm

i **3**

Ďalšie informácie

19 mm 19 mm 19 mm

85 mm

12,50

515.0855 1/2" 3 x 19 mm

i **3**

Ďalšie informácie

17 mm 19 mm 21 mm

85 mm

15,00

515.0875 1/2" 17 - 19 - 21 mm

i **3**

Ďalšie informácie

21 mm 19 mm 17 mm

85 mm

18,00

515.1070 1/2" 17 - 19 - 21 mm

i **3**

Ďalšie informácie

EXTRA DLHÝ

38,00

150 mm

21 mm 19 mm 17 mm

515.0865 1/2" 17 - 19 - 21 mm

i **5**

Ďalšie informácie

15 mm 17 mm 19 mm 21 mm 22 mm

85 mm

26,00

515.0870 1/2" 15 - 17 - 19 - 21 - 22 mm

i **10**

Ďalšie informácie

17 mm 15 mm 19 mm 22 mm 23 mm

85 mm

72,00

1/2" 15 - 17 - 19 - 21
22 - 23 - 24 mm

515.0890 7/8" 17 mm MS21

21 mm 17 mm 21 mm 24 mm

i **17**

Ďalšie informácie

15 mm 17 mm 19 mm 21 mm 22 mm 23 mm 24 mm

85 mm

145,00

17 mm 21 mm

18,5 mm 19,5 mm 20,5 mm 21,5 mm 17,5 mm 22,5 mm

21 mm 19 mm 17 mm

515.0885 1/2" 15 - 17 - 19 - 21 - 22 - 23 - 24 mm 7/8" 17 mm MS21 17 - 19 - 21 mm 18,5 / 19,5 - 20,5 / 21,5 - 17,5 / 22,5 mm



VÁŠ SILNÝ PARTNER

PRE DIELŇU PRE ÚŽITKOVÉ VOZIDLÁ
S NAJVÄČŠÍM VÝBEROM NÁRADIA PRE ÚŽITKOVÉ VOZIDLÁ



**ROBUSTNÉ ŠPECIÁLNE NÁRADIE PRE
NAJNÁROČNEJŠIE POUŽITIA!**



**STRANY
528**

**VÝROBOK
>6.000**

**KAPITOLA
23**

www.kstools.com

Predaj len prostredníctvom špecializovaných obchodov.



i **1**
 Další informace

Oblasti použití:
 Volvo FM a FH



Ø 75 mm

480,00

Napínač pružiackej jednotky
 pre tlmiče kabíny vodiča

460.5700

i **9**
 Další informace

→ DAF - IVECO
 MAN - RENAULT
 VOLVO - SCANIA



455.0110

Prístroj na preverenie chladiaceho
 systému nákladných vozidiel



299,00

i **1**
 Další informace

NEW



455.0195

Vákuový plniaci systém pre chladiaci systém

165,00

i **5**
 Další informace

NEW

→ SCANIA



460.3985

Súprava na montáž tesniacich krúžkov pre Scania

299,00

i **5**
 Další informace

NEW

→ FUSO - IVECO



M16 x 2

M12 x 1,25

460.4475

Súprava na montáž tesniacich krúžkov pre Fuso a Iveco

150,00

i **1**
 Další informace

→ MERCEDES - MAN



1/2"

70 - 170 mm

Oblasti použitia:
 Mercedes Actros a Atego,
 MAN 5-/6- a 8-vaľcové
 motory - D25/28 atď.

455.0021

Zariadenie na pretáčanie motora pre Mercedes / MAN

134,00



i **6**
 Ďalšie informácie



MAN - MERCEDES



Oblasti použitia:
 vložky valca pre MAN, Mercedes atď.



Ø 60 - 160 mm

549,00



460.1815 Súprava vyťahovačov valcových puzdiel

i **5**
 Ďalšie informácie



VOLVO

344,00



Oblasti použitia: Volvo FM12

460.1805 Súprava sťahovačov puzdiel injektorov pre Volvo

i **14**
 Ďalšie informácie

**TOP
 SELLER**

135,00



i **3**
 Ďalšie informácie



KNORR

55,00

NEW



i
 Pre Deutsch DT

460.0505 Súprava náradia na uvoľnenie zástrčky pre brzdú Knorr

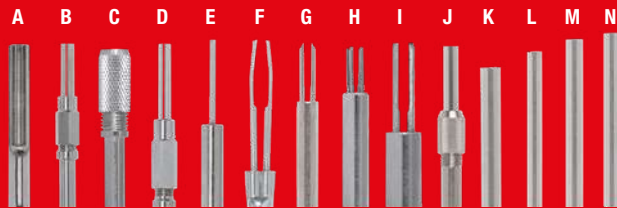

- | | | | |
|---|---|---|--|
| A | 4,0 mm, (ABS) | H | 1,5 mm |
| B | 3,5 mm (AMP Tyco 3,5) | I | 2,5 mm |
| C | 4,0 mm | J | 5,5 mm |
| D | 2,5 mm (AMP Tyco 2,3, Delphi 2,3, GHW 2,3) | K | Ø 1,5 mm (AMP Tyco 1,5) |
| E | 2,8 mm (AMP Tyco JT, AMP Tyco ST, DT) | L | Ø 3,5 mm (AMP Tyco 3,5) |
| F | 2,8 mm, 4,8 mm, 5,8 mm, 6,3 mm (AMP Tyco JPT, AMP Tyco SPT, AMP Tyco, TAB, Delphi HVF2, GHW DFK, GHW MDK 3) | M | Ø 2,3 mm (AMP Tyco 2,3, Delphi 2,3, GHW 2,3) |
| G | 2,8 mm | N | 4,0 mm |

150.1215 Súprava odblokovacieho náradia pre úžitkové vozidlá



24V



Ďalšie informácie



DAF CF85

NEW



Ø 119,7 mm

Ø 125 mm

Ø 148 mm

Ø 138 mm

300,00

Súprava náradia

na montáž a demontáž ložísk nábojov pre DAF

460.4350



Ďalšie informácie



VOLVO FM12

NEW



Ø 109 mm

Ø 147 mm

Ø 124 mm

175,00

Súprava náradia

na montáž a demontáž ložísk nábojov pre VOLVO

460.4010



Ďalšie informácie



Ø 30 mm

Ø 27 mm

Ø 25 mm

Ø 20 mm

Ø 36 - 45 mm

Ø 42 - 52 mm

208,00

UNIVERSAL

TOP
SELLER

150.2450

súprava univerzálneho spojovacieho a strediaceho náradia pre úžitkové vozidlá

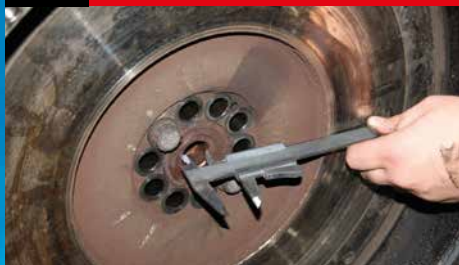



od **29,00**



A	460.0012			EPL 32	44,0	50,0	29,00 €
B	460.0013			EPL 32	44,0	90,0	39,00 €



Ďalšie informácie

95,00

M22 x 90



7.000 kg

450.0070

Univerzálny sťahovák guľových kĺbov



Ďalšie informácie



SAF
MERCEDES



Oblasť použitia:
nápravy SAF a Mercedes

1500,00

460.4885

Súprava náradia pre 3D puzdrá pre nápravy SAF, Mercedes DCA a HT



Ďalšie informácie



VOLVO - DB/RENAULT
MAN TGA - SAF

Použitie:
Ø 51 mm - Volvo FM12
Ø 60 mm - DB / Renault (430/450/460)
Ø 68 mm - MAN-TGA (140/414/460) pružina
prednej nápravy ROR, SAF



max.
12t



TOP
SELLER



Ø 68 mm
MAN-TGA
(410/414/460)



Ø 51 mm
VOLVO(FM12)



Ø 60 mm
RENAULT
(430/450/460)



1995,00

460.1705

Súprava náradia pre drážkované puzdrá silentblokov

*CEJN® je zapísaná ochranná známka združenia Cejn AB, Skövde, Švédsko.



Ďalšie informácie

- vhodné na rýchle vtláčanie a vytlačenie výkyvných čapov
- lisovacia jednotka je otočná o 360°
- výkyvná, otočná a s výškovým nastavovaním pre ťažko dostupné súčiastky
- vrátane pneumatického hydraulického nožného čerpadla s rýchlym zdvihom, hydraulickým valcom, najbežnejšími puzdrami a prítlačnými kusmi
- vysoká úspora nákladov a času

Technické údaje:

Kapacita:	75 t
Zdvih:	160,0 mm
max. prevádzkový tlak:	700 bar
Objem:	1,8 l

4600,00



Ø 24 mm

Ø 34 mm

Ø 47 mm

Ø 47 mm

Ø 47 mm



Ø 39 mm



Ø 50 mm



Ø 61 mm



Ø 95 mm



460.3620

Lis na výkyvné čapy 75t so súpravou puzdier



NEW

i **1**
 Další informace

i
 Oblasť použitia:
 Predná náprava DAF LF45

DAF

75 mm

Ø 76 mm

Ø 88 mm

3/4"

115,00

460.3740 Klúč na drážkové matice so 4 čapmi pre DAF

i **1**
 Další informace

MAN - MERCEDES

185 mm

Ø 49 mm

Ø 80 mm

Ø 95 mm

3/4"

258,00

Špeciálny kľúč na drážkové matice so 6 čapmi pre MAN a Mercedes

450.0160

i **1**
 Další informace

MAN

Ø 101 mm

Ø 110 mm

80 mm

3/4"

198,00

450.0170 Klúč na drážkové matice so 6 čapmi pre MAN

i **1**
 Další informace

MAN TGA

Ø 67 mm

Ø 133 mm

Ø 148 mm

160 mm

3/4"

339,00

Klúč na drážkové matice s vodiacou rúrou, MAN TGA

450.0175

i **1**
 Další informace

SAF

85 mm

Ø 118 mm

36 mm

82 mm

185,00

450.0201 Klúč na axiálne matice pre SAF

i **1**
 Další informace

SCANIA

80 mm

Ø 98 mm

75 mm

1"

140,00

Klúč na axiálne matice pre Scania

450.0221



i **27**
 Další informácie

SAUER - BPW
 SCANIA - FUSO - HINO

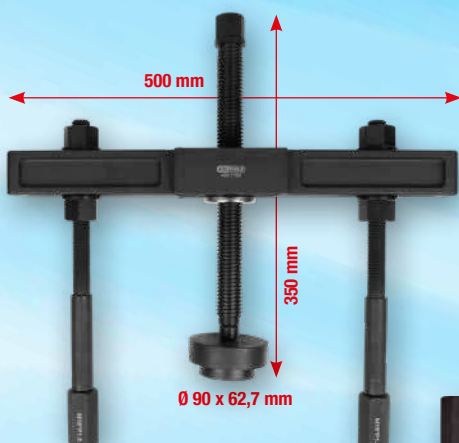

1145,00



2 x M18x1,5
 2 x M20x1,5
 2 x M22x1,5
 2 x M24x1,5
 2 x M30x1,5
 2 x 7/8"x11G



460.1765 Univerzálna súprava sťahovákov nábojov kolies nákladných vozidiel

i **1**
 Další informácie

metrický: 1,0 - 1,25 - 1,5 - 1,75 - 2,0 - 2,5 - 3,0 - 3,5 mm
 palcový: 24 - 20 - 18 - 16 - 14 - 12 - 11,5 - 11 - 10 - 9 - 8 - 7,5 - 7 - 6 - 5 - 4 otáčok/palec



**TOP
 SELLER**

195,00

150.1430 Hrebeňový závitový nôž na vonkajší závit Ø 25 - 140 mm

i **9**
 Další informácie



i **9**
 Další informácie



9 x

1/2": KM4-KM5-KM6-KM7-KM8
 3/4": KM9-KM10-KM11-KM12

364,00

Súprava nástrčkových kľúčov pre KM
 drážkové matice, vonkajšie čapy

450.5000



Oblasti použitia:
 montáž a demontáž valivých ložísk, ozubených
 kolies, kuželíkových ložísk, guľôčkových ložísk
 atď.
 poľnohospodárska technika, lesnícka a
 komunálna technika, stavebné stroje, priemysel,
 úžitkové vozidlá atď.



9 x



1/2": KM4-KM5-KM6-KM7-KM8
 3/4": KM9-KM10-KM11-KM12

453,00

Súprava nástrčkových kľúčov pre KM drážkové
 matice, vnútorné čapy

450.5020



performance

NÁŠ ROZSIAHLÝ SORTIMENT AUTOMOBILOVÝCH ZDVIHÁKOV NA STRANÁCH 95 AŽ 103.



Ďalšie informácie



Ďalšie informácie

NEW



599,00

460.5500 Súprava na montáž a demontáž kolesových skrutiek



Ďalšie informácie



NEW



460.1300



Ďalšie informácie



905,00

Vhodné pre tesnenia hriadeľa zadnej nápravy Mercedes ACTROS a ATEGO (vrátane ACTROS s 11,5 t; 13 t a 16 t AP náprav)

460.5580 Súprava náradia na montáž tesniaceho krúžka pre Mercedes



i **7** **VOLVO**

Ďalšie informácie

NEW

Ø 156 mm Ø 148 mm Ø 124 mm

Ø 147 mm Ø 134 mm Ø 127 mm

310,00

Pre tesniace krúžky:
3985463, 098*Ø125*8L, 800792A, 800792C, Ø125*Ø148*9.7L

Pre ložiská kolies:
F-566426, H195, F-566425, H195, F-800792.28.

460.4050 Súprava náradia na montáž tesniaceho krúžka pre Volvo

i **36**

Ďalšie informácie

Oblasti použitia: Knorr (SB, SN a SK), Wabco (PAN 19-1 a PAN 22-1), Haldex Modul T (SAF, SBS2220 H0)

1096,00

460.4720 Súprava na opravu brzdového strmeňa

i **5** **SAF**

Ďalšie informácie

TOP SELLER

12 mm

41,00

171 mm

12 mm

8 mm 8 mm

10 mm M9

Súprava špeciálnych nástrčkových kľúčov pre piest brzdy pre kotúčové brzdy WABCO a Knorr

460.2615

i **1**

Ďalšie informácie

TOP SELLER

150 mm

45 mm

Ø 18 mm

189,00

Výstružník pre snímač ABS nákladných vozidiel

450.0340

i **1**

Ďalšie informácie

Rázový kľúč Torx-E s 2 nárazovými plochami

L mm

B mm

3/4"

od 50,00

		B mm	L mm	
517.0908	E18	30	215	50,00 €
517.0910	E20	32	220	54,00 €
517.0914	E24	38	220	54,00 €

i **1**

Ďalšie informácie

140 mm

41,00

T60

CR-MO 22mm

3/4"

3/4"

Súprava silových nástrčných bitov pre skrutky Torx, dlhé

450.0441



ROBUSTNÁ KVALITA V CELEJ SVOJEJ KRÁSE!

TOP SELLER

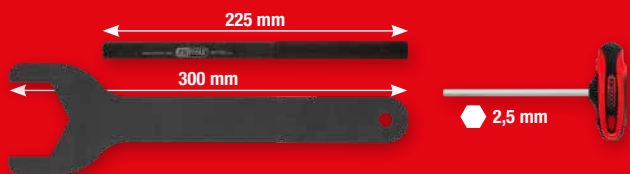

2590,00



Ø 4 / 91 mm Ø 6 / 92 mm Ø 6 / 110 mm Ø 8 / 94 mm Ø 9 mm Ø 13 mm Ø 16 mm



Ø 9,5 / 75 mm Ø 13,5 / 75 mm Ø 13,5 / 97 mm



Ø 16,5 / 75 mm Ø 7,4 / 15,9 mm Ø 9,4 / 11,8 mm



KRÁTKY PRÍPRAVNÝ ČAS

460.0605 Vzduchovo-hydraulická nitovačka



NEW



i
KNORR

45,00

Uvoľňovacie náradie na vložku sušičky vzduchu pre Volvo/Renault

460.0501



NEW



90,00

Uvoľňovacie náradie na odstránenie výpustnej hadice vzduchového kompresora

460.5666



i **1**
 Ďalšie informácie

79,00



1/2"

Ø 0-170 mm

Retázový kľúč na vložku olejového filtra a vzduchovej sušičky

460.5216

i **1**
 Ďalšie informácie

26,00



28 - 60 mm

250 mm

150.1995

Kliešte na veko kolesových matic

i **7**
 Ďalšie informácie

128,00

1:64

3.800 mm

27 mm 30 mm 32 mm 33 mm 1" 1"

300 mm

TOP SELLER

Súprava univerzálnych znásobačov sily

516.1180

Súprava univerzálnych znásobačov sily

i **1**
 Ďalšie informácie



45,00

32 mm

24 mm

630 mm

27 mm

3/4"

518.1155

Križový kľúč na kolesá nákladných vozidiel



Šesťhranový silový nástrčný orech, extra dlhý

od 39,00

EXTRA DLHÉ



3/4"

		mm	L mm	D1 mm	D2 mm	T mm	
515.1184		32,0	270,0	49,0	44,0	32,0	39,00 €
515.1193		32,0	400,0	49,0	44,0	32,0	45,00 €
515.1194		33,0	400,0	50,0	44,0	32,0	50,00 €

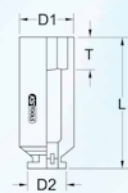

i **5**
 Ďalšie informácie

59,00

150.1080

Súprava na vulkanizáciu pneumatík pre úžitkové vozidlá



30 x 178 mm

70 g

9 mm

VOLITEĽNÉ

19,00

150.1082

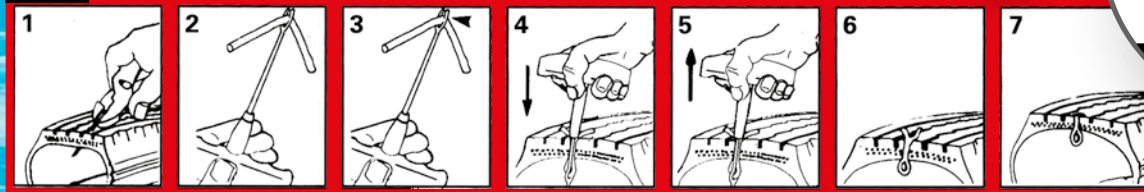

STAŇTE SA MILIONÁROM!

FRÁZA, KTOREJ DÔVERUJE VIAC AKO MILIÓN ZÁKAZNÍKOV!



Váš partner



KS Tools Werkzeuge und Maschinen GmbH

Seligenstädter Grund 10 - 12
63150 Heusenstamm

Mail: customerservice@kstools.com
Web: www.kstools.com

NEMECKO

Po vyjdení tohto prospektu strácajú všetky predchádzajúce ceny svoju platnosť. Predaj len prostredníctvom špecializovaných obchodov. Tlačové chyby, omyly a technické zmeny sú vyhradené. Všetky ceny v EUR bez DPH platia do 30.9.2025.

917.0779

**SÚPRAVA NÁSTRČKOVÝCH KLÚČOV,
179-DIELNA**

iba
98,00